



## **AC/ DC Clamp Ammeter User Manual**

- **CM2100**
- **CM2100B**

**For product support, visit: [www.owon.com.hk/download](http://www.owon.com.hk/download)**

**Apr 2023 edition V1.0.2**

Copyright © LILLIPUT Company. All rights reserved.

The LILLIPUT's products are under the protection of the patent rights, including ones which have already obtained the patent rights and those which are applying for. The information in this manual will replace all materials published.

The information in this manual was correct at the time of printing. However, LILLIPUT will continue to improve products and reserves the rights to change specification at any time without notice.

**owon**<sup>®</sup> is the registered trademark of the LILLIPUT Company.

**Fujian LILLIPUT Optoelectronics Technology Co., Ltd.**

No. 19, Heming Road

Lantian Industrial Zone, Zhangzhou 363005 P.R. China

**Tel:** +86-596-2130430

**Fax:** +86-596-2109272

**Web:** [www.owon.com.cn](http://www.owon.com.cn)

**E-mail:** [info@owon.com.cn](mailto:info@owon.com.cn)

# General Warranty

We warrant that the product will be free from defects in materials and workmanship for a period of 1 year from the date of purchase of the product by the original purchaser from our Company. This warranty only applies to the original purchaser and is not transferable to the third party, and does not apply to fuses, disposable batteries or to any product which has been misused, altered, neglected or damaged by accident or abnormal conditions of operation or handling.

If the product proves defective during the warranty period, we either will repair the defective product without charge for parts and labor, or will provide a replacement in exchange for the defective product. Parts, modules and replacement products used by our company for warranty work may be new or reconditioned like new performance. All replaced parts, modules and products become the property of our company.

In order to obtain service under this warranty, Customer must notify our company of the defect before the expiration of the warranty period. Customer shall be responsible for packaging and shipping the defective product to the service center designated by our company, and with a copy of customer proof of purchase.

This warranty shall not apply to any defect, failure or damage caused by improper use or improper or inadequate maintenance and care. We shall not be obligated to furnish service under this warranty a) to repair damage resulting from attempts by personnel other than our company representatives to install, repair or service the product; b) to repair damage resulting from improper use or connection to incompatible equipment; c) to repair any damage or malfunction caused by the use of not our supplies; or d) to service a product that has been modified or integrated with other products when the effect of such modification or integration increases the time or difficulty of servicing the product.

Please contact the nearest Sales and Service Offices for services.

**Excepting the after-sales services provided in this summary or the applicable warranty statements, we will not offer any guarantee for maintenance definitely declared or hinted, including but not limited to the implied guarantee for marketability and special-purpose acceptability. We should not take any responsibilities for any indirect, special or consequent damages.**

# Table of Contents

I. Basic Overview .....	1
II. General Inspection .....	1
III. Safety Information .....	1
Safety Considerations .....	1
Measurement Category .....	3
Safety Terms and Symbols .....	3
IV. Product Panel Diagram .....	4
V. LCD Full-Display Diagram .....	5
VI. Operation Instructions .....	6
VII. To Connect with Mobile Device .....	11
Installation of Free APP .....	11
How to Connect with Mobile Device .....	12
User Interface .....	13
APP Related Operations .....	14
VIII. Technical Specifications .....	32
IX. Care and Maintenance .....	35
X. Appendix .....	36

# I. Basic Overview

CM2100 AC/ DC clamp ammeter is characterized by high reliability, high safety, high accuracy and small size. Its resolution reaches 1mA and the maximum range is 100A AC\DC. This product has unique VFC start-up mode and can accurately measure the voltage and current of VFC after entering the mode; it has true virtual value response of voltage or current, full range overload protection, reliable measuring precision and unique appearance design so that it becomes a new generation of practical electrical/ electric measuring instrument.

# II. General Inspection

After you get a new clamp ammeter, make a check on the instrument according to the following steps:

## 1. Check whether there is any damage caused by transportation.

If it is found that the packaging carton or the foamed plastic protection cushion has suffered serious damage, do not throw it away first till the complete device and its accessories succeed in the electrical and mechanical property tests.

## 2. Check the Accessories

The supplied accessories have been already described in the Appendix of this Manual. You can check whether there is any loss of accessories with reference to this description. If it is found that there is any accessory lost or damaged, please get in touch with our distributor responsible for this service or our local offices.

## 3. Check the Complete Instrument

If it is found that there is damage to the appearance of the instrument, or the instrument can not work normally, or fails in the performance test, please get in touch with our distributor responsible for this business or our local offices. If there is damage to the instrument caused by the transportation, please keep the package. With the transportation department or our distributor responsible for this business informed about it, a repairing or replacement of the instrument will be arranged by us.

# III. Safety Information

## Safety Considerations

**Before any operations, please read the following safety precautions to avoid any possible bodily injury and prevent damage to this product or any other products connected. To avoid any contingent danger, use this product only as specified.**

### EC Declaration of Conformity:

Meets intent of Directive 2004/108/EC for Electromagnetic Compatibility.

- Limit operation to the specified measurement category, voltage, or amperage ratings.
- **Do not use the clamp ammeter if it is damaged.** Before you use the clamp ammeter, inspect the case. Look for cracks or missing plastic. Pay particular attention to the insulation surrounding the connectors.
- **Do not use the test leads provided for other products.** Use only the certified test leads specified for this product.
- Inspect the test leads for damaged insulation or exposed metal.
- Before use, verify the clamp ammeter's operation by measuring a known voltage.
- Only the qualified technicians can implement the maintenance.
- **Always use the specified battery type.** The power for the clamp ammeter is supplied with a battery. Observe the correct polarity markings before you insert the batteries to ensure proper insertion of the batteries in the clamp ammeter.
- **Check all Terminal Ratings.** To avoid fire or shock hazard, check all ratings and markers of this product. Refer to the user's manual for more information about ratings before connecting to the clamp ammeter.
- Do not operate the clamp ammeter with the cover or portions of the cover removed or loosened.
- **Use Proper Fuse.** Use only the specified type and rating fuse for the clamp ammeter.
- **Do not operate if in any doubt.** If you suspect damage occurs to the clamp ammeter, have it inspected by qualified service personnel before further operations.
- **To avoid electric shock, do not operate this product in wet or damp conditions.**
- **Do not operate in an explosive atmosphere.**
- **Keep product surfaces clean and dry.**
- Do not apply more than the rated voltage (as marked on the clamp ammeter) between terminals, or between terminal and earth ground.
- When servicing the clamp ammeter, use only the specified replacement parts.
- Use caution when working above 60 V DC, 30 V AC RMS, or 42.4 V peak. Such voltages pose a shock hazard.
- When using the test leads, keep your fingers behind the finger guards on the test leads.
- Remove the test leads from the clamp ammeter before you open the battery cover.
- To avoid false readings, which may lead to possible electric shock or personal injury, replace the battery as soon as the low battery indicator  appears and flashes.
- Disconnect circuit power and discharge all high-voltage capacitors before testing resistance, continuity, diodes, or capacitance.
- **Use the proper terminals, function, and range for your measurements.** When the range of the value to be measured is unknown, set the rotary switch position as the highest range, or choose the auto ranging mode. To avoid damages to the clamp ammeter, do not exceed the maximum limits of the input values shown in the technical specification tables.
- Connect the common test lead before you connect the live test lead. When you disconnect the leads, disconnect the live test lead first.
- Before changing functions, disconnect the test leads from the circuit under test.

## Measurement Category

The clamp ammeter has a safety rating of 1000 V, CAT III and 600 V, CAT IV.

### Measurement category definition

**Measurement CAT I** applies to measurements performed on circuits not directly connected to the AC mains. Examples are measurements on circuits not derived from the AC mains and specially protected (internal) mains- derived circuits.

**Measurement CAT II** applies to protect against transients from energy-consuming equipment supplied from the fixed installation, such as TVs, PCs, portable tools, and other household circuits.

**Measurement CAT III** applies to protect against transients in equipment in fixed equipment installations, such as distribution panels, feeders and short branch circuits, and lighting systems in large buildings.

**Measurement CAT IV** applies to measurements performed at the source of the low- voltage installation. Examples are electricity meters and measurements on primary over current protection devices and ripple control units.

## Safety Terms and Symbols

### Safety Terms

**Terms in this Manual.** The following terms may appear in this manual:



**Warning:** Warning indicates the conditions or practices that could result in personal injury or death.



**Caution:** Caution indicates the conditions or practices that could result in damage to this product or other property.

**Terms on the Product.** The following terms may appear on this product:

**Danger:** It indicates an injury or hazard may immediately happen.







**Warning:** It indicates an injury or hazard may be accessible potentially.

**Caution:** It indicates a potential damage to the instrument or other property might occur.

### Safety Symbols

**Symbols on the Product.** The following symbol may appear on the product:

	Direct current (DC)		Fuse
--	---------------------	--	------

	Alternating current (AC)		Caution, risk of danger (refer to this manual for specific Warning or Caution information)
	Both direct and alternating current	<b>CAT II</b>	Category II overvoltage protection
	Ground terminal	<b>CAT III</b>	Category III overvoltage protection
	Conforms to European Union directives	<b>CAT IV</b>	Category IV overvoltage protection
	Equipment protected throughout by double insulation or reinforced insulation		

## IV.Product Panel Diagram

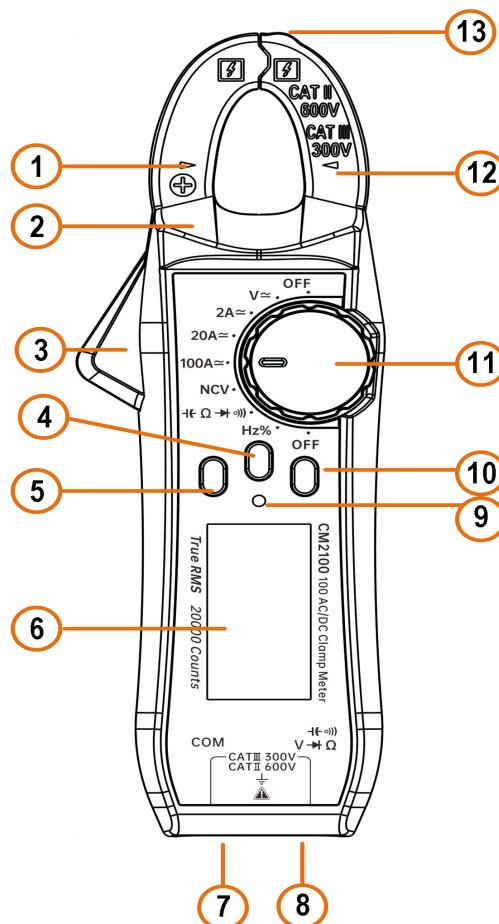

**Figure 1**

1. Clamp head.
2. Protective baffle plate.
3. Clamp head trigger: Press the trigger to open the clamp head.
4. ZERO button: It is used for making DCA to zero, relative capacitance/voltage



- measurement/ press and hold the button for about 2 seconds to enable/ disable Bluetooth.
5. HOLD/ Backlight Button: It is used for locking measured reading / press and hold the button for about 2 seconds to enable/ disable backlight.
  6. LCD display: Displays measurement function, symbols and values.
  7. COM input jack: The black probe is inserted this jack when this product is used to test voltage, resistance/ continuity /capacitance/diode, frequency/duty cycle.
  8. Positive end input jack: The red probe is inserted this jack when this product is used to test voltage, resistance/ continuity /capacitance/diode, frequency/duty cycle.
  9. NCV and alarm indicator: It will flash when the induced AC electric field strength and sensing distance meet the specified value or the measurement of other gear exceeds the range.
  10. SELECT button: Used to select the functions, such as ACV/DCV, resistance/ continuity /capacitance/diode, ACA/DCA, frequency/duty cycle, etc. when AC current and voltage function is selected, if you press and hold this button for 2 seconds to enter or exit the VFC function.
  11. Function Selection knob: Rotate this knob to switch over the corresponding function indicated on the panel.
  12. The geometric center indication mark of the clamp head.
  13. NCV induction antenna.

## V. LCD Full-Display Diagram

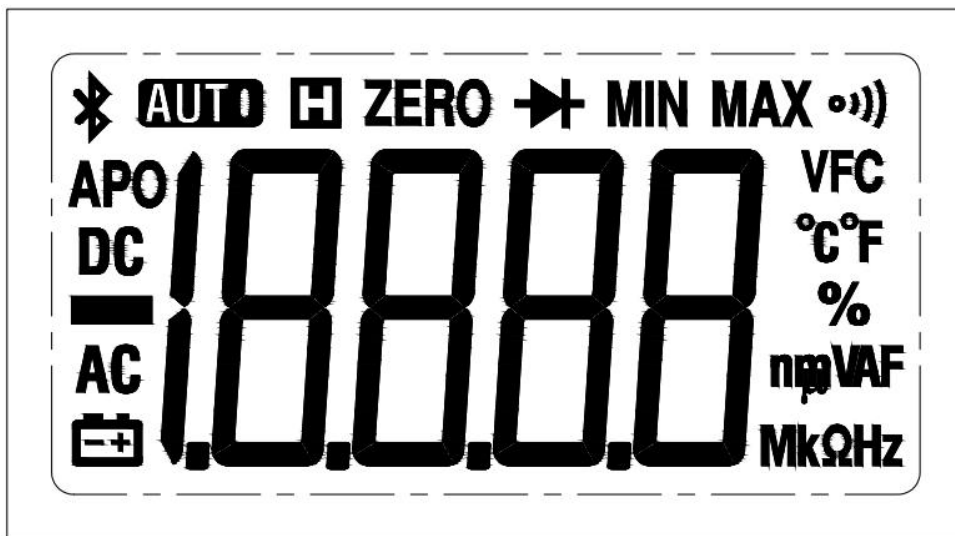

Figure 2

No.	Symbol	Description
1	✱	Enable Bluetooth
2	AUTO	Automatic range
3	☐	Enable reading holding mode
4	ZERO	Zeroing base number
5	➤	Select diode test

6		Select continuity test
7	<b>VFC</b>	Prompt of variable frequency voltage/ current measurement
8	<b>°C°F</b>	Measurement unit of temperature, °C/ °F
9	<b>%</b>	Percentage: Select duty cycle measurement
10	<b>mVAF</b>	Measurement unit of voltage, current and capacitance
11	<b>MkΩHz</b>	Measurement unit of resistance and frequency
12	<b>18888</b>	Measured value display; if the measured value is out of range, "OL" will be displayed
13		Insufficient battery level
14	<b>AC</b>	AC
15		Negative polarity indication of current or voltage
16	<b>DC</b>	DC
17	<b>APO</b>	Automatic shutdown

## VI. Operation Instructions

### 1. Measurement of AC/ DC Voltage

- Select AC or DC voltage function.
- Insert the red probe into the red hole (positive pole) and the black probe into the black hole (COM terminal).
- Get the red and black probes to contact tested parts, such as power outlets, etc. (Figure 3).
- Read the measured value from the LCD screen.

When it is used to measure voltage, the maximum input voltage value is 600V (AC/ DC) and the measured value cannot exceed this limit, or else it is easy to cause the risk of electric shock and may do damage to the instrument.

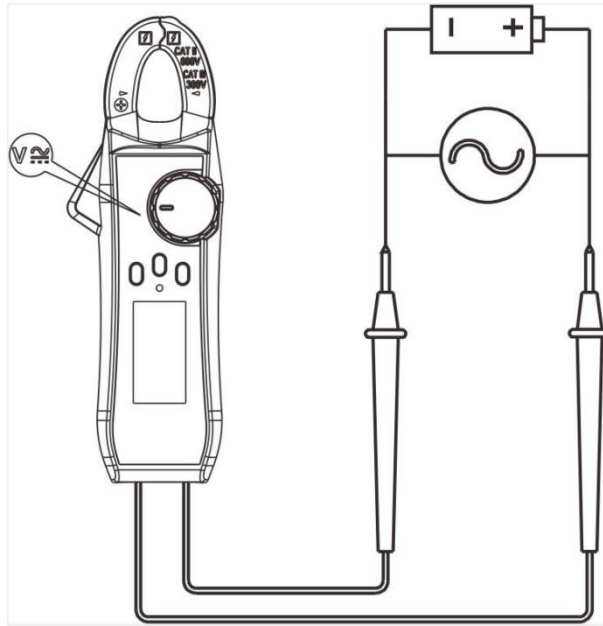

**Figure 3**

## **2. Measurement of AC/ DC Current (Figure 4 and 5)**

### ● AC Current

- a. Select the current range (2A, 20A, 100A): Press SELECT/ V.F.C button to enable the AC current flow function.
- b. Open the clamp head and hook the wire (single wire) so that the wire is placed in the geometric center position indicated on the clamp head; ensure that the left and right clamp heads are completely closed, and there is no gap between the left and right clamp heads.
- c. Read the measured data from the LCD.

### ● DC Current

- a. Select the current range (2A, 20A, 100A): Press SELECT/ V.F.C button to enable the DC current flow function, and press the ZERO key before measurement to make the reading zero value. Note: Due to the high sensitivity of the product, in order to ensure the accuracy of the measurement reading, the direction of the instrument measurement should be as consistent as possible with the direction of zero.
- b. Open the clamp head and hook the wire (single wire) so that the wire is placed in the geometric center position indicated on the clamp head; ensure that the left and right clamp heads are completely closed, and there is no gap between the left and right clamp heads.
- c. Read the measured data from the LCD. A positive reading indicates that the current flows from the positive pole of the clamp head to the negative pole, and a negative reading indicates that the current flows from the negative pole of the clamp head to the positive pole.



Before measuring current, please remove the test probe to avoid electric shock.

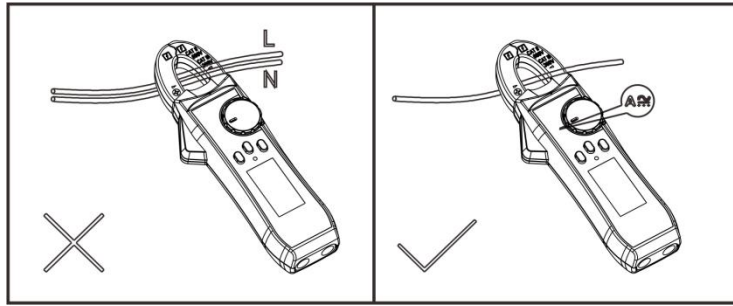

Figure 4

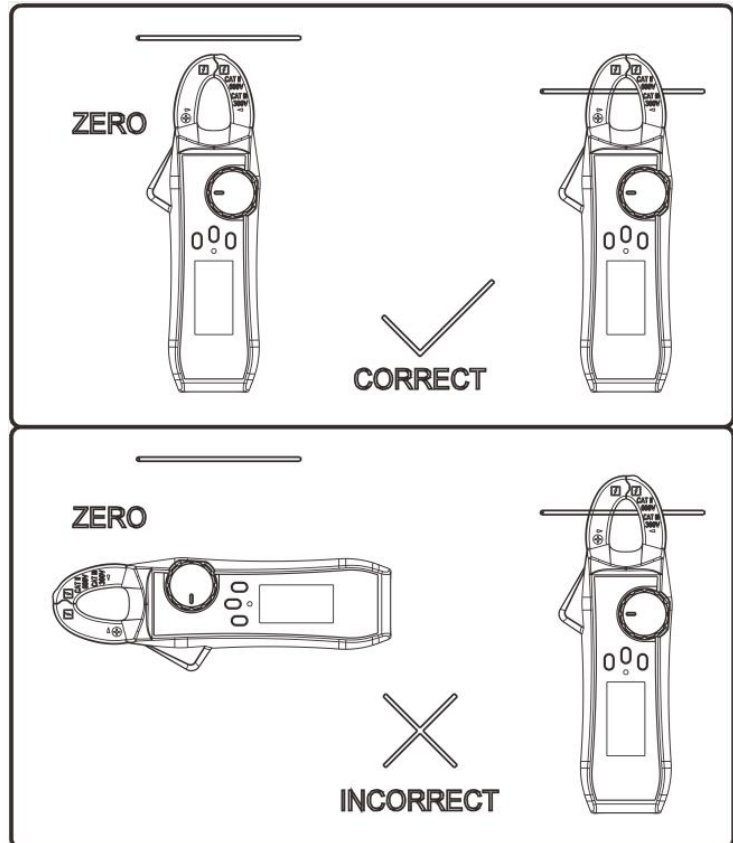



Figure 5

### 3. Non-Contact Electric Field Measurement and Setting (Figure 6)

If you need to measure whether there is an AC voltage in the space, please select the NCV function and keep the NCV antenna at the front end of the instrument clamp head close to the measured object at a distance of about 8-15mm for induction detection. If the induced voltage is less than 90V, EF will be displayed, and if the induced voltage is greater than 90V, "-" will be displayed; four segments ("- - -") are set according to voltage and there are beeps in different rhythms in different segments, accompanied by a flicker of the NCV indicator to distinguish the intensity of the induced voltage.

 When the function is switched to NCV, please remove the test probe to avoid electric shock.

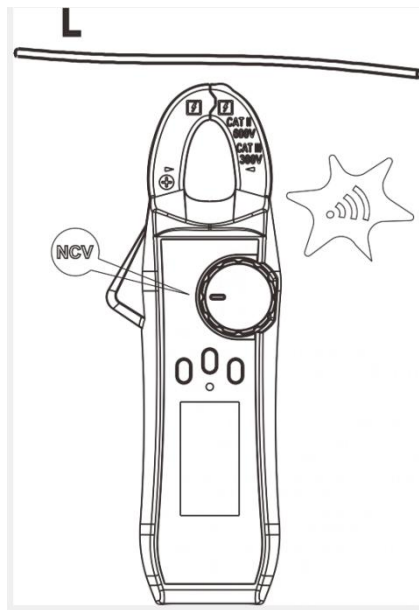

Figure 6

#### 4. Resistance / Circuit ON/OFF/ Diode/ Capacitance

- Select resistance/ continuity /capacitance/diode function.
- Insert the red probe into the red hole (positive pole) and the black probe into the black hole (COM terminal).
- Connect the probes to the tested part for measurement (Figure 7)
- Read the measured data from the LCD screen.

**⚠** When the instrument is switched to resistance/ continuity /capacitance/diode function, the input voltage cannot be higher than 60V (DC) or 30V (AC) to guarantee personal safety.

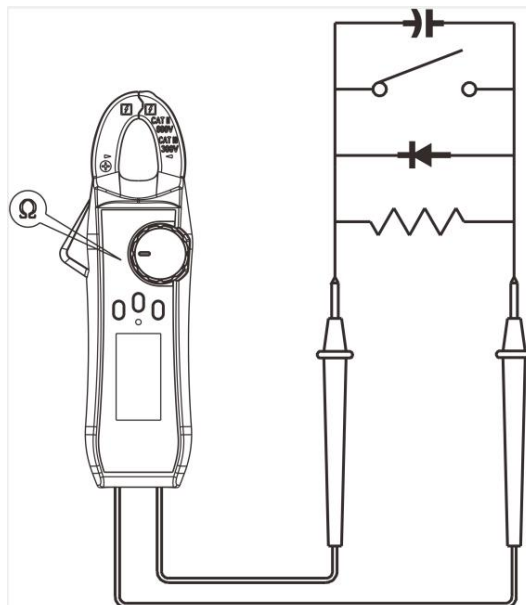

Figure 7

#### 5. Measurement of Frequency and Duty Cycle

- Select frequency/duty cycle function.
- Insert the red probe into the red hole (positive pole) and the black probe into the black hole

(COM terminal).

- Get the red and black probes to contact the tested part, such as power socket (Figure 8).
- Read the measured data from the LCD screen.

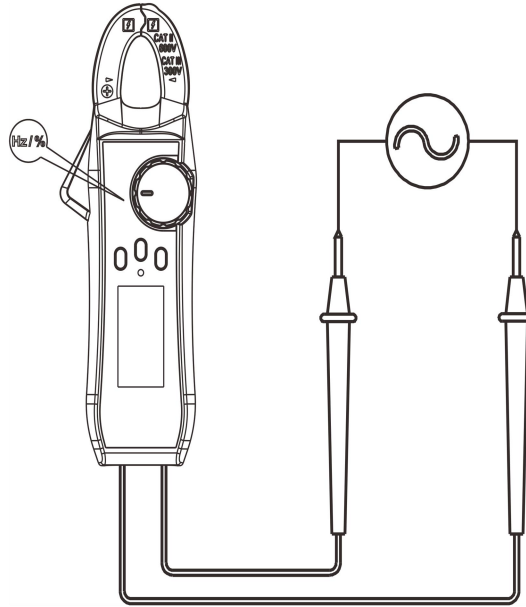

Figure 8

## 6. Other Functions

- Press and hold the HOLD button for about 2 seconds to turn on or off LCD backlight function.
- Automatic Shutdown: If the knob switch cannot be operated in about 15 minutes in the measurement process, the meter will "automatically shut down" to save energy. In the state of automatic shutdown, turn the knob switch to OFF position and restart the machine, or click any button to wake up the instrument.
- Enable automatic shutdown:  
Press and hold the SELECT key, and then turn on the power switch to start up the instrument, then there are three beeps, indicating that the automatic shutdown function is canceled. When the machine is turned off and then turned on, the automatic shutdown function will be restored. About 1 minute before the automatic shutdown of the instrument, the buzzer will ring 3 times continuously for warning, and the buzzer will give a long beep for warning before shutdown. When the automatic shutdown function is canceled, three continuous alarm beeps will be given every 15 minutes.
- Buzzer: There is a "Beep" (about 0.25 seconds) from the buzzer when you press any button or turn the function switch and the function button is effective. In the **•|)** mode, if the tested circuit is well conducted ( $\leq 50\Omega$ ), the buzzer will ring continuously; when the measured voltage or current exceeds the range, there are continuous intermittent "Beeps" from buzzer for over-range warning. The functional status is shown as follows:
  - a. When AC/DC voltage  $> 600V$ , there is beep for warning.
  - b. Low voltage detection: When the battery voltage is lower than 2.5V, the "**⊖+**" battery undervoltage symbol will be displayed, in this case, the measurement accuracy may be reduced and the battery needs to be replaced in time; when the battery voltage is lower than 2.2 V, only the battery undervoltage symbol will be displayed in the full display after boot and

the instrument cannot work.

## VII. To Connect with Mobile Device\_Only for CM2100B

The AC/DC clamp ammeter can communicate with the mobile device through Bluetooth connection, making the measurement more secure. You can view the measured data of the AC/DC clamp ammeter, perform remote control, display data charts, and store the measurement data in CSV format on the mobile terminal through the free application software. The number of records that can be stored in the mobile APP is based on the remaining storage space on your mobile device. A mobile phone can be connected to several AC and DC clamp ammeters at the same time.

**Note:** The effective distance of Bluetooth communication is 7~ 8 meters, and is further in a wide range of open and unshielded environment, even more than 20 meters. The Bluetooth function of the AC/DC clamp ammeter will be automatically turned off after 10 minutes of inactivity. Before the automatic shutdown, there are two short "beeps".

### Installation of Free APP

#### Requirements of APPs in Different Versions for Mobile Device System

- **Bluetooth 4.0 Android APP**

It is applicable for Android 6.0 or above systems and Bluetooth BLE 4.0 Android devices.

- **Bluetooth 4.0 iOS APP**

It is applicable for iOS11.0 or above systems and Bluetooth BLE 4.0, but not applicable for iPhone 5 and older models.

#### For Android device

Please use your mobile device to scan the QR code below, click the APP installation package, download and install it.





#### For iPhone

You can search "OWON iMeter" on Apple Store, click the  icon to obtain the APP installation package, download and install it.

**Note:** The following help contents may not be completely consistent with the latest APP and be for reference only. The latest version of the User's Manual can be obtained from our website.

## How to Connect with Mobile Device

- (1) Download and install the free AC/DC clamp ammeter APP on the mobile device.
- (2) Enable Bluetooth on the mobile device, and open the "AC/DC clamp ammeter" APP.
- (3) After the AC/DC clamp ammeter is turned on, please hold and press the ZERO/  button until the  Bluetooth sign appears in the upper left corner of the display.
- (4) Click "+" button in the upper left corner of the mobile device to add the AC/DC clamp ammeter.

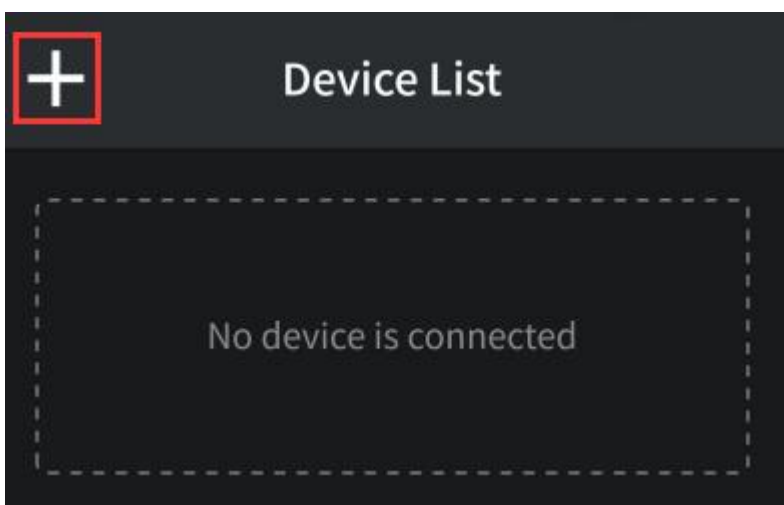

- (5) Enter the "Add Device" interface.

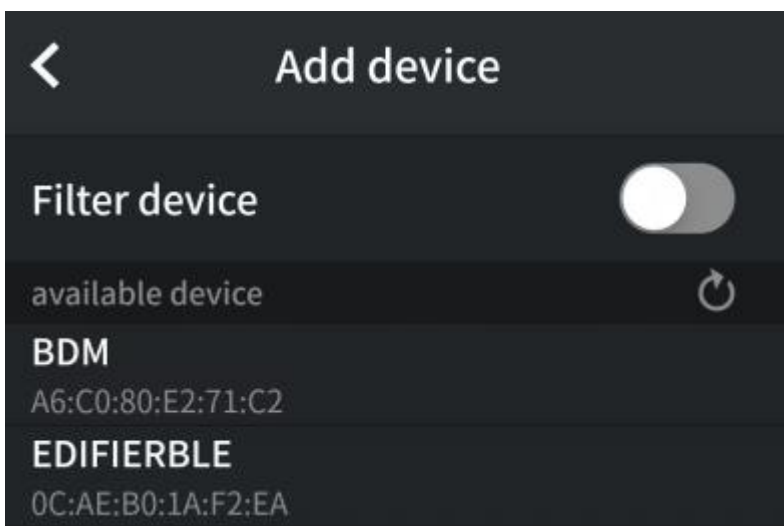

- (6) Select the required AC/DC clamp ammeter in the "Available devices".



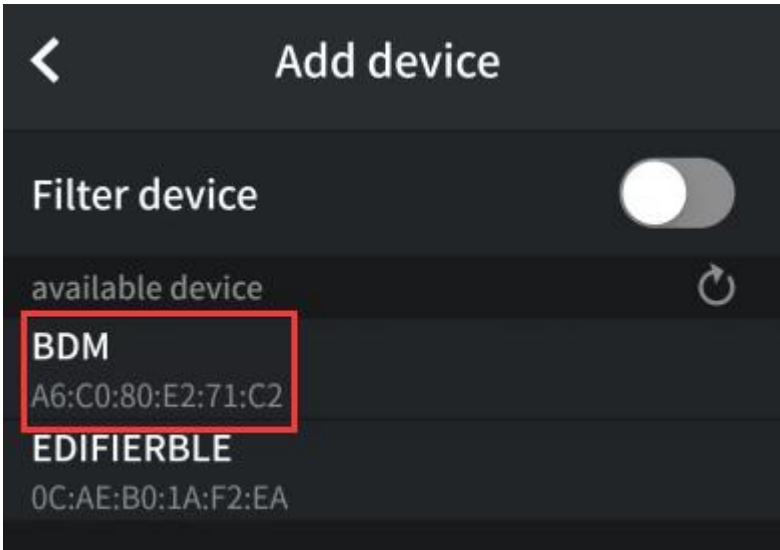

(7) You can also filter out and select the required AC/DC clamp ammeter by opening the "Filter device".

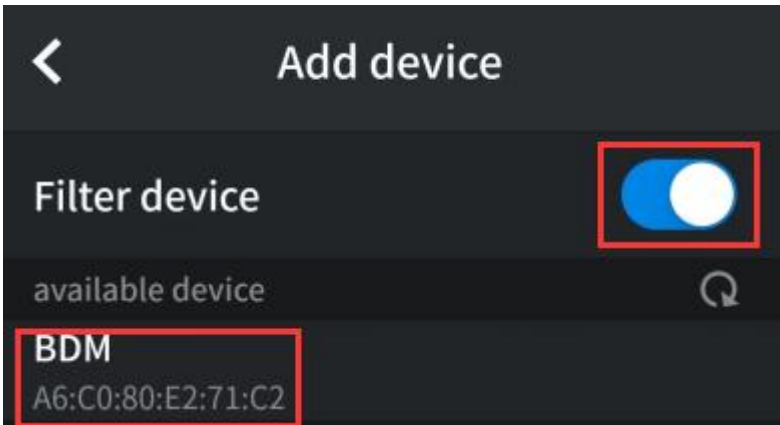

(8) After selecting the device, click it to enter the List of Devices.

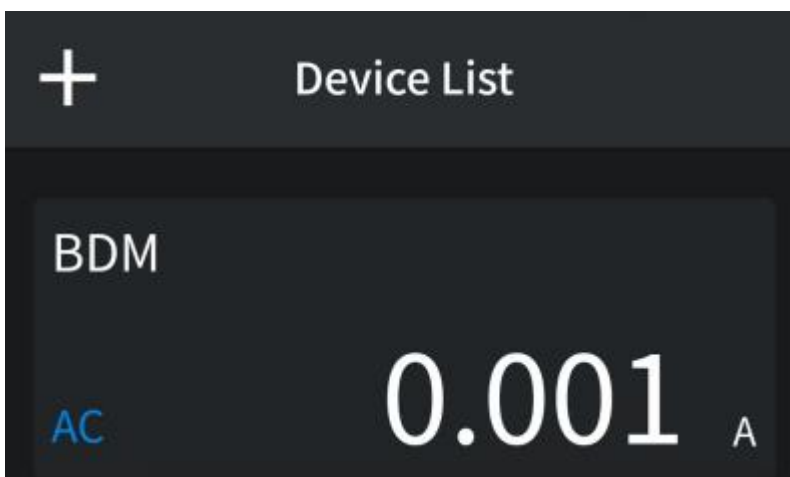

## User Interface

Please click the desired device in the List of Devices before entering the use interface of AC/DC clamp ammeter, as shown in the figure below:

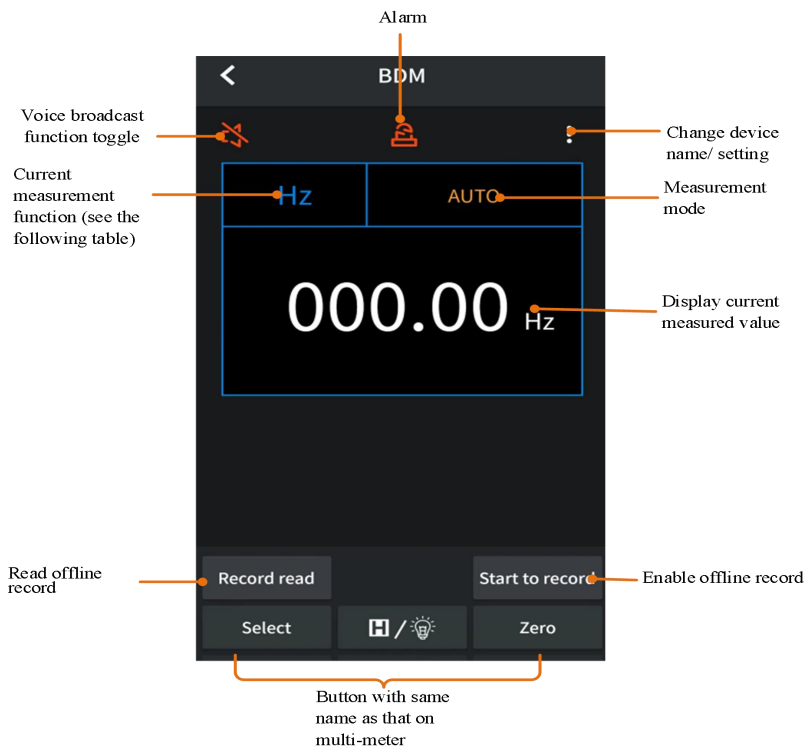

## Function Table

Code	Function
DC	DC
AC	AC
NCV	Non-contact voltage measurement
RES	Resistance measurement
CAP	Capacitance measurement

Code	Function
DIODE	Diode measurement
CONT	Continuity test
Hz	Frequency measurement
DUTY	Duty cycle measurement

## APP Related Operations

### Device List

- Add AC/DC clamp ammeter: Click  soft key in the device list.
- **Select AC/DC clamp ammeter:** Directly click the required AC/DC clamp ammeter in the device list.
- **Delete AC/DC clamp ammeter:** In the device list, click the AC/DC clamp ammeter to be deleted, slide it to the left, and then click "Delete" button.
- **Wireless control:** In the device view, press or press and hold the Control button in the same way as the operation button on the AC/DC clamp ammeter to achieve the corresponding control.
- **Custom AC/DC Clamp Ammeter Name**

1. The user can customize the display name of the AC/DC clamp ammeter on the current device.  
Click  icon in the top right corner of the view interface.

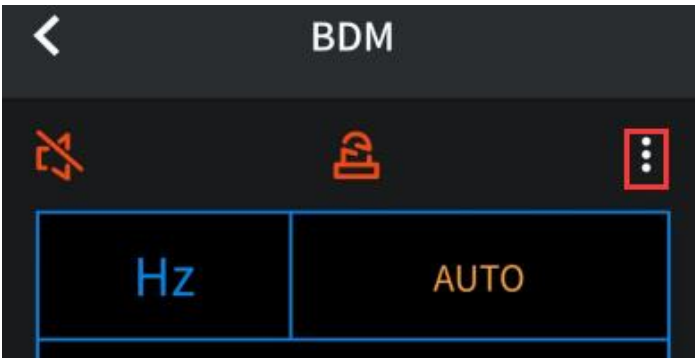

2. Go to the "More Settings" interface.

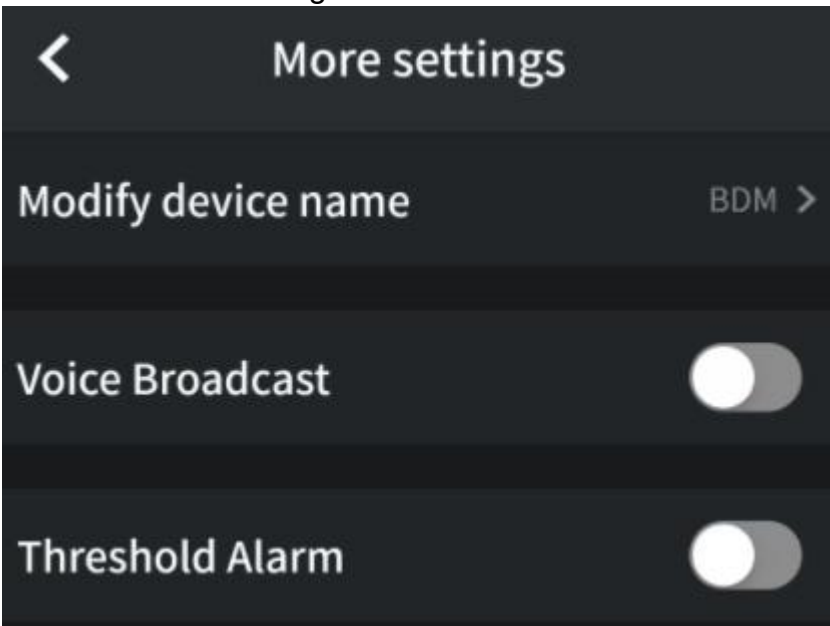

3. Click "Modify device name" button.

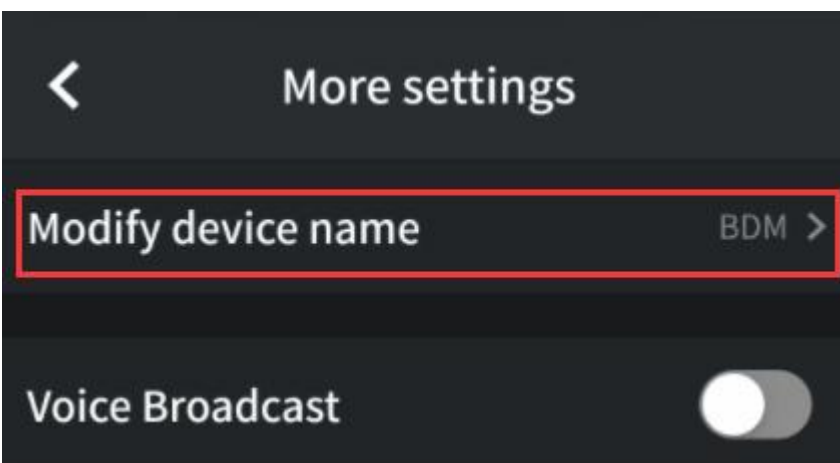

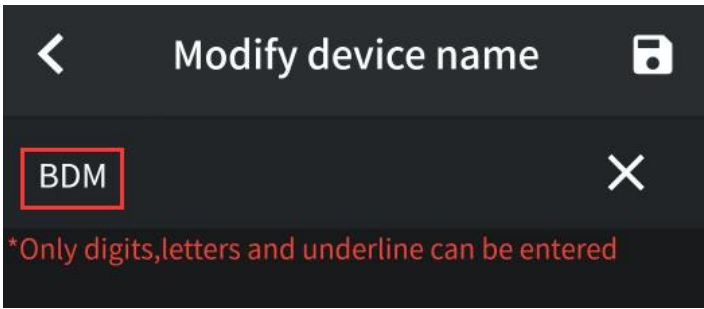

4. Enter the "Modify device name" interface and enter the custom name of the device.

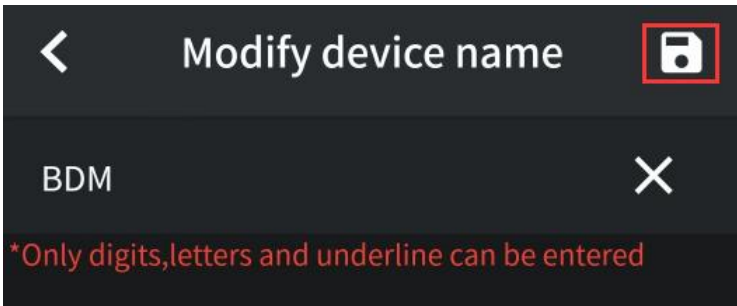

5. Click  icon in the upper right corner of the interface to save the device name modified.



- **Voice broadcast:** Click  icon in the upper left corner of the single view interface or click  icon in the upper right corner to enter More Settings interface and enable or disable voice broadcast function.
  - **Over-range alarm:** In the setting interface, you can turn on the alarm switch and set the upper/lower limits of the alarm. When the measured value is greater than the upper limit or less than the lower limit, the APP will give an alarm for over-range prompt.
1. Click  icon in the top right corner of the view interface.

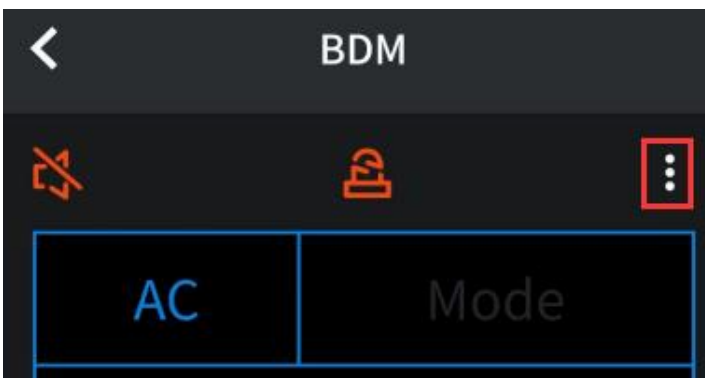

2. Go to the "More Settings" interface.

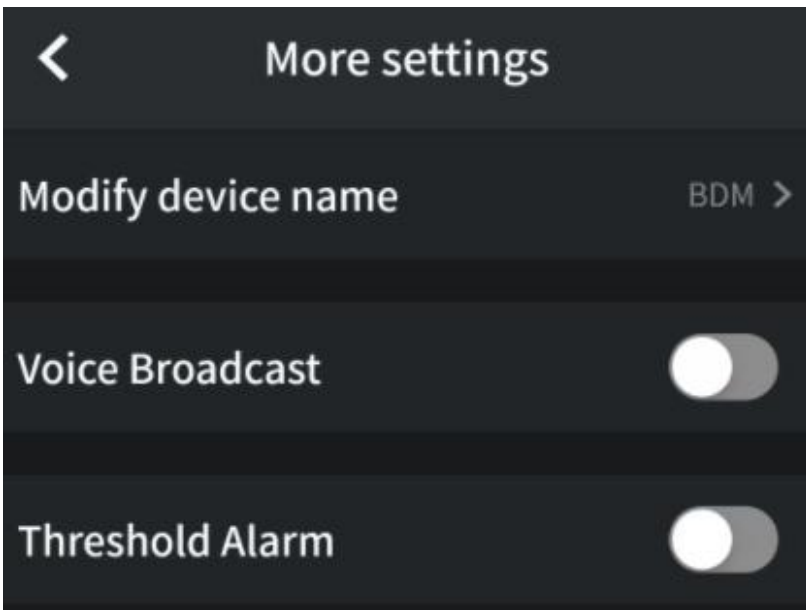

3. Click it to enable "Threshold Alarm".

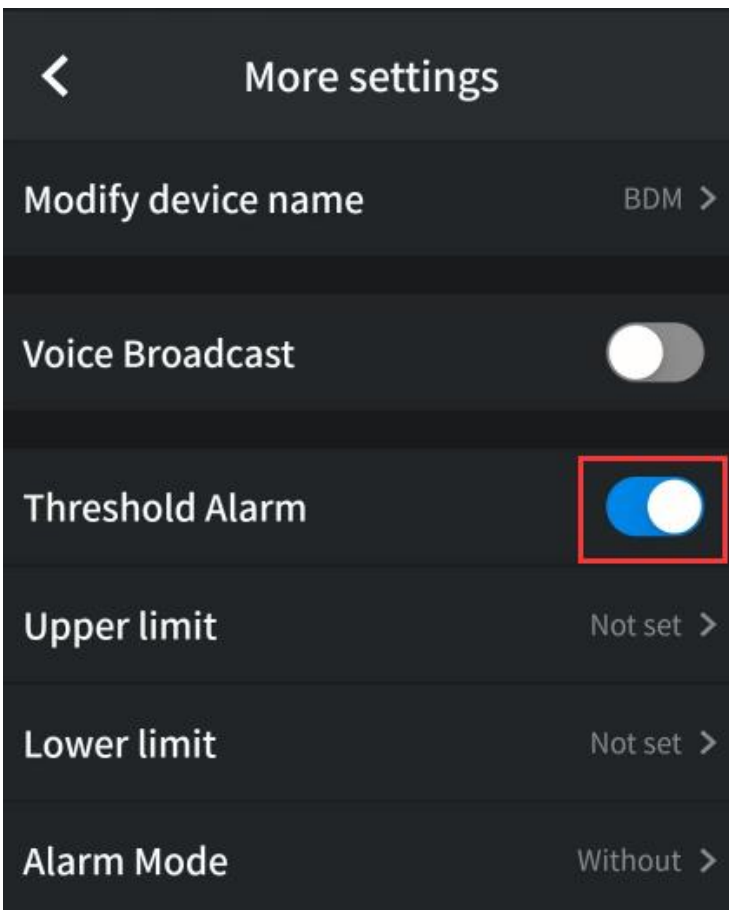

4. Click to set the required values and modes of "Upper limit, Lower limit and Alarm mode" (within range & outside range)

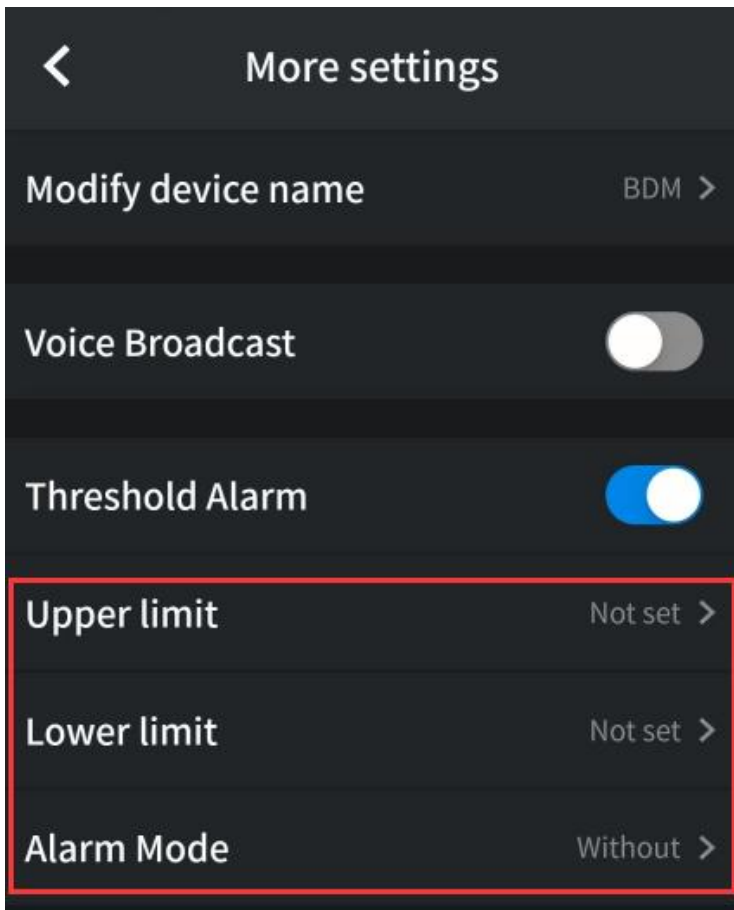

## ● Offline Recording Function of AC/ DC Clamp Ammeter

When the AC/DC clamp ammeter is used for measurement, the device APP sends a command to enable offline recording function of AC/DC clamp ammeter. After receiving the command, the AC/DC clamp ammeter is automatically disconnected, and can automatically save the measurement data in the storage area of the instrument under offline state. After completing the recording, reconnect the AC/DC clamp ammeter in the APP, and read the measured data and save it in a CSV file. This function can realize the automatic and unmanned recording of data for a long time to reduce Bluetooth power consumption and save the electric quantity of AC and DC clamp ammeter.

**Note:** When the "🔋" symbol appears on the display of the AC/DC clamp ammeter (in low battery level), the offline recording function may be abnormal. Before using this function, please check the battery level of the AC/DC clamp ammeter to ensure sufficient battery level.

- (1) Connect the device to the AC/DC clamp ammeter, as shown in "How to Connect with Mobile Device on P12."
- (2) In APP device view, click "Start to record" button.



- (3) In the "Start to record" interface, set the **record interval** and the **record counts**. The record counts can be set to a maximum of 10,000. After setting, click "Start to record" button. Only the single off-line recorded data can be stored in the storage area of the AC/DC clamp ammeter. Therefore, when the recording begins, the last off-line record data stored in the AC/DC clamp ammeter will be overwritten.
- After clicking it, the APP interface directly disconnects. The AC/DC clamp ammeter starts to record the current measurement data in the storage area.

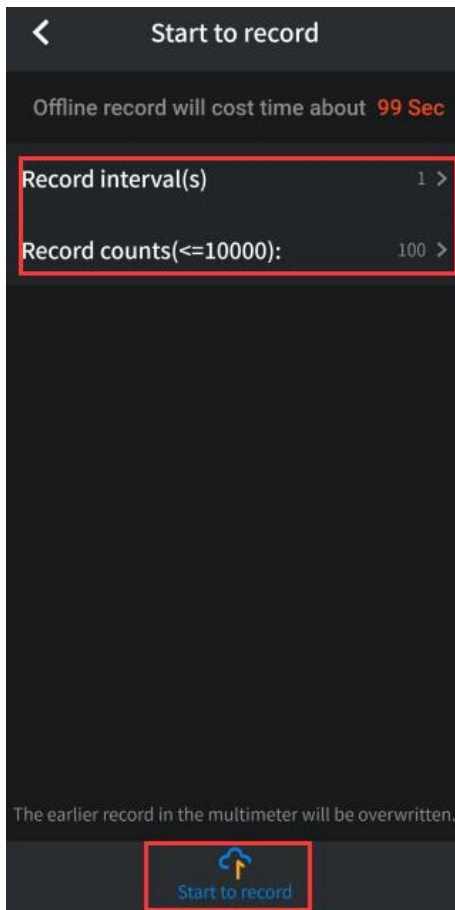

**Note:** When the AC/DC clamp ammeter is in the data recording state but the recording has not been completed, if you connect the Android device to the AC/DC clamp ammeter at this time, the following selection box will pop up:

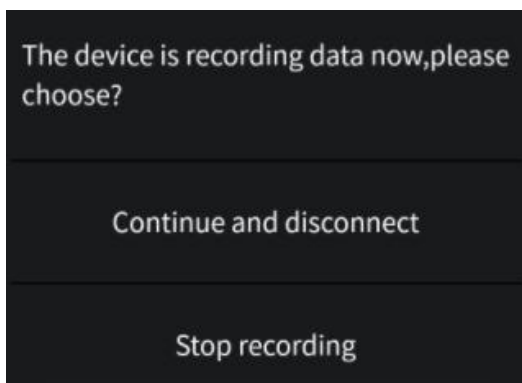

- If you select **Stop recording** option, the data recording of the AC/DC clamp ammeter will be interrupted and the Android device is connected to the AC/DC clamp ammeter. You can proceed to the next step to read the record.
  - If you select **Continue and disconnect** option, then the AC/DC clamp ammeter will continue to record data, and will not be connected with the Android device temporarily.
- (4) After the recording is completed, please reconnect the Android device to the AC/DC clamp ammeter to read the data recorded offline.
  - (5) In APP device view, click "Record read " button.



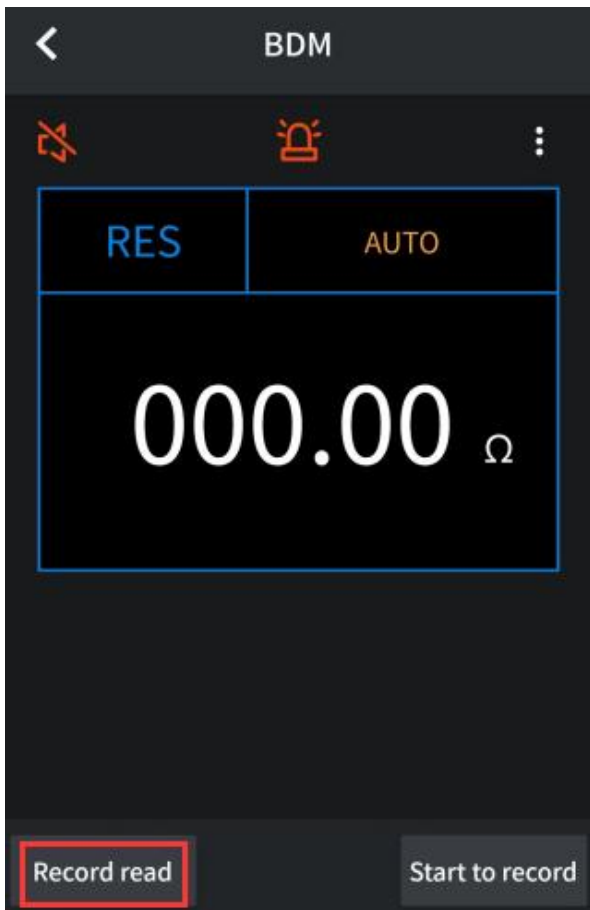

(6) In the off-line record reading interface, click "Save as: XXX" button.

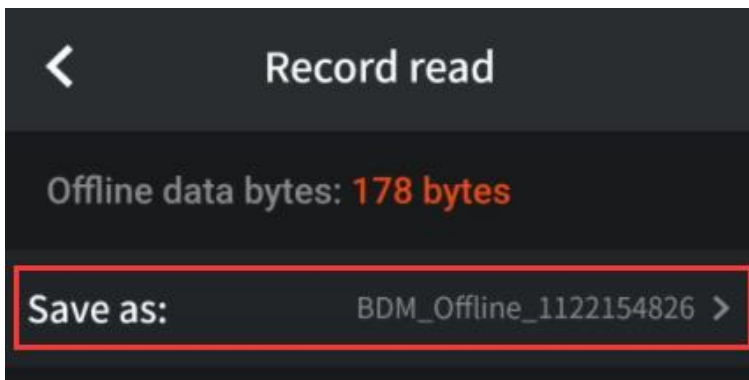

(7) Offline data files can be named.

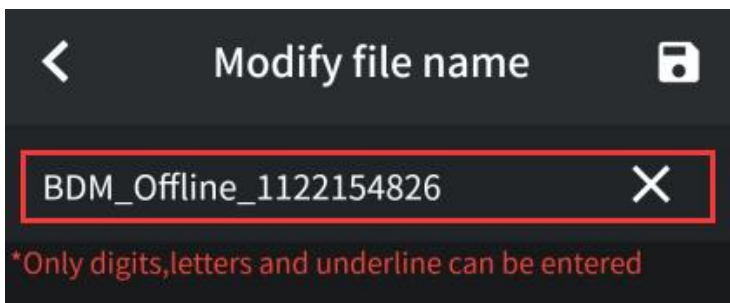

(8) Click "Read data" button to read the measurement data through the APP and save it in the zip format.

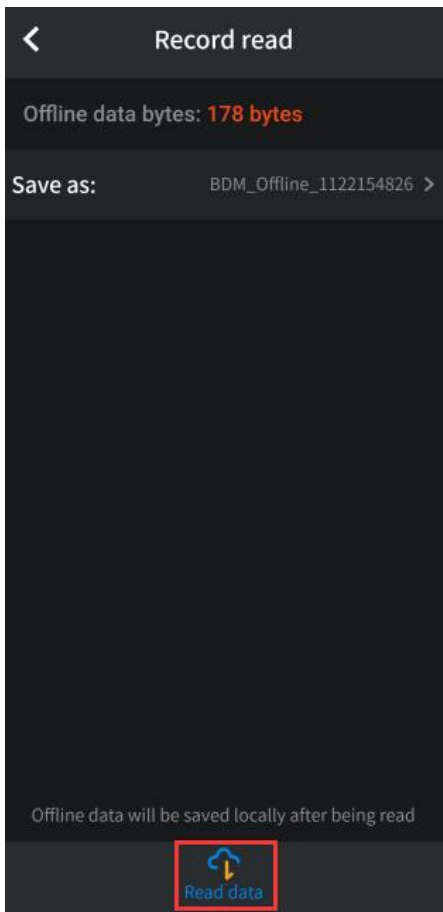

(9) After reading the data, click "Display data" button.

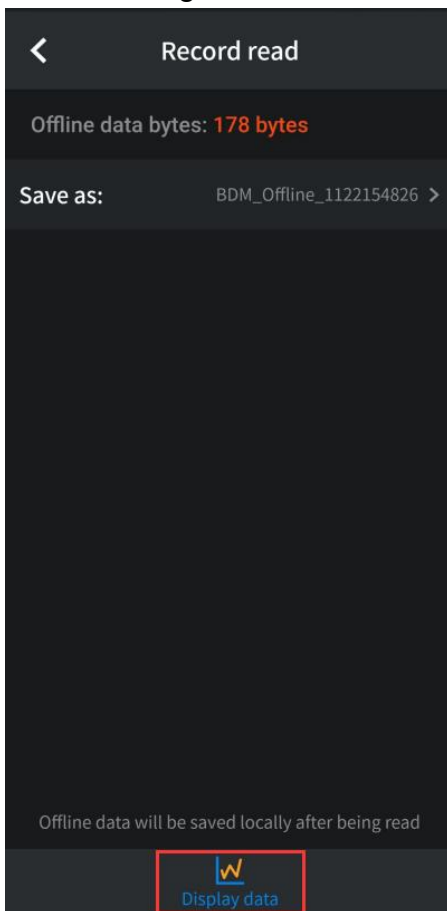

(10) The data display interface is shown as follows:

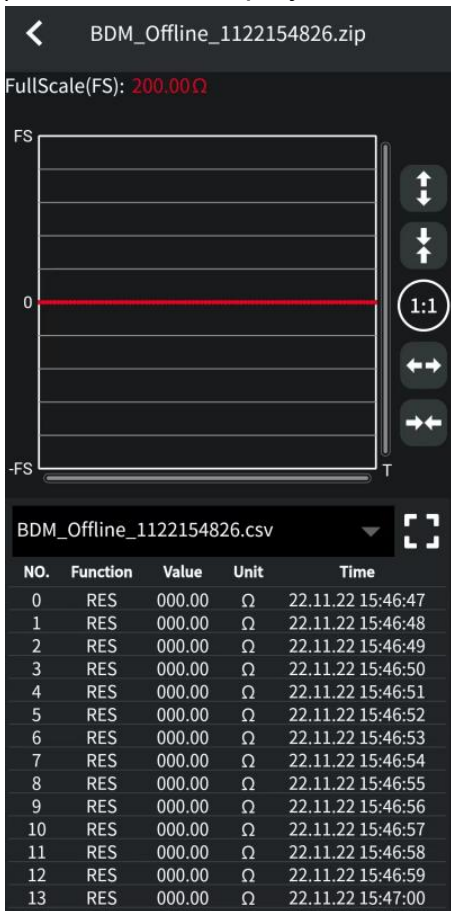

## Real-Time Data

- **Real-Time Data:** Click  Real-Time Data button to enter the real-time data interface.

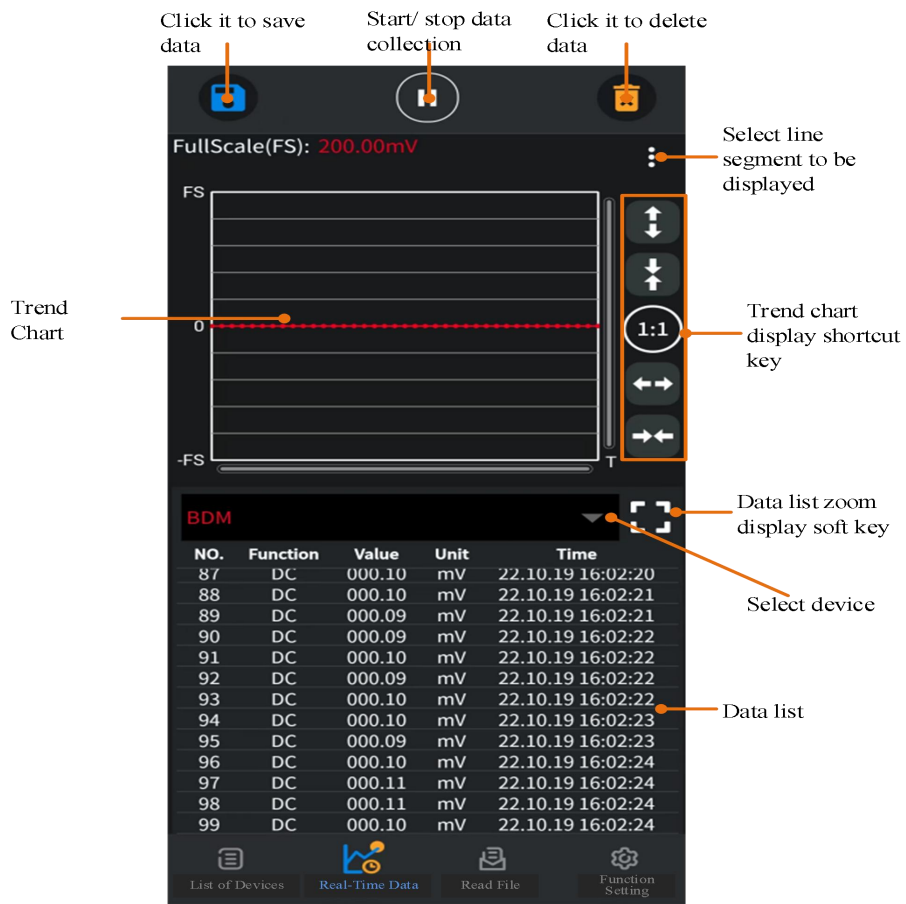

## Read File

1. Click  Read File button to enter the document reading interface.

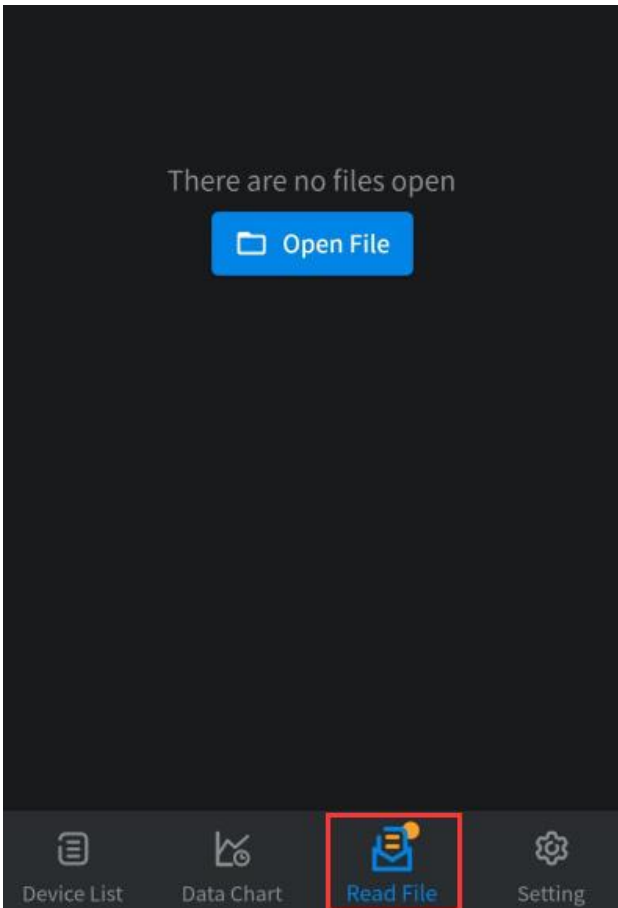

2. Click "Open File" button.

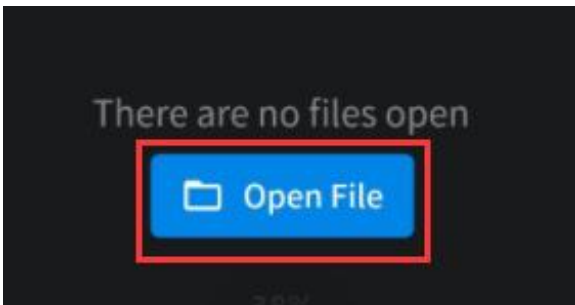

3. Enter "Local File" interface.

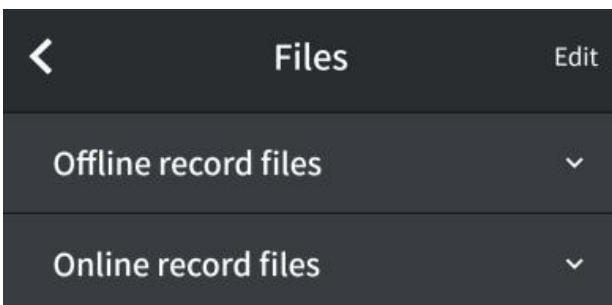

4. Select the desired data file (offline data file & real-time data file) according to the need; take "real-time data file" for an example, the operation steps are shown as follows:
  - a. Click "Real-Time Data File" in the local file interface.

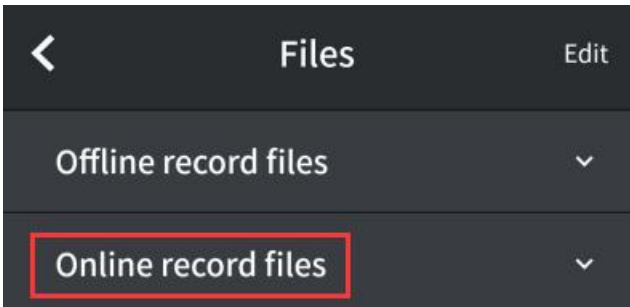

- b. Enter the real-time data file interface and click the required data file.

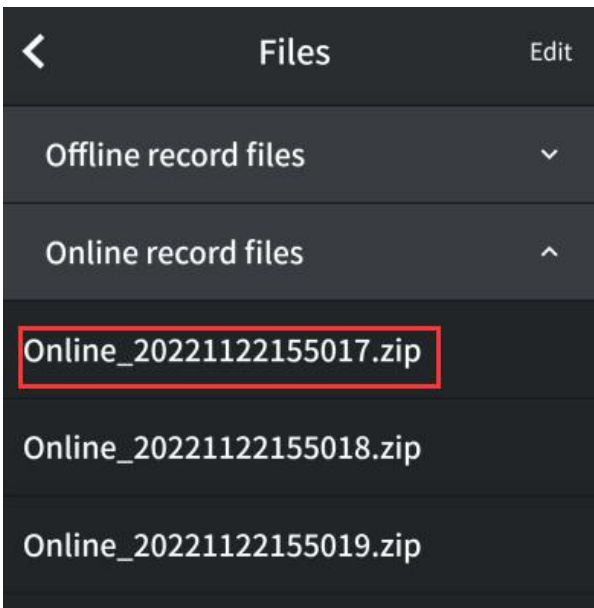

- c. Enter the data file editing interface, and perform the following operations on the data file: Load data, Share, Rename, Remove and Cancel.

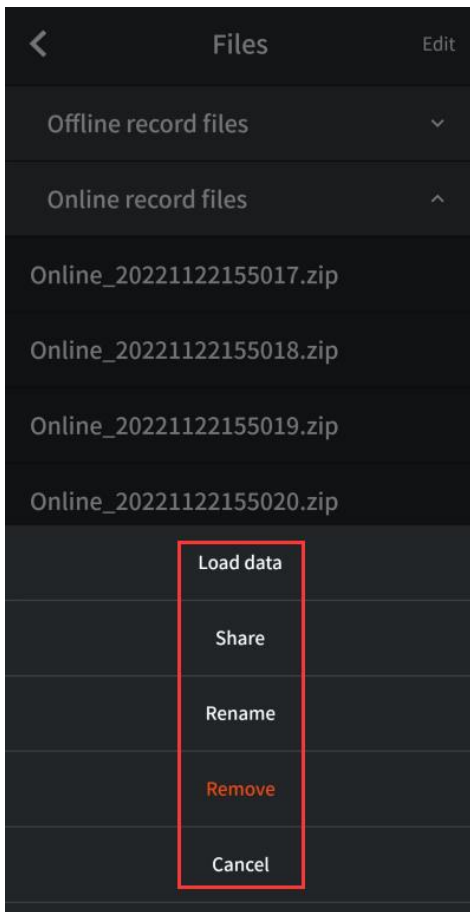

## Function Setting

1. Click  Function Setting button to enter the function setting interface.

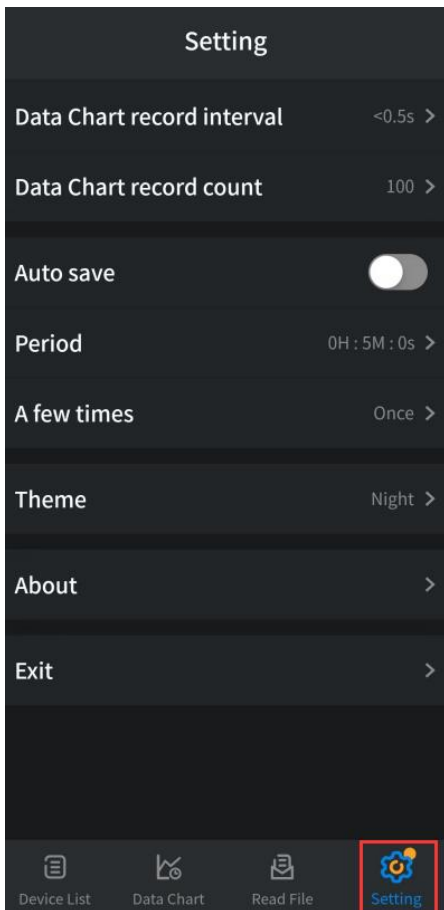

## 2. Setting Data Chart record interval

- a. After the interval time of each data is set in the real-time data interface, the data shall be refreshed and recorded in real-time data interface according to the set interval time;
- b. Click **Data Chart record interval** button and then set the recording interval time in the display box below (setting range: 1s~11h: 59m: 59s);
- c. After setting the required interval time, click **Save** button to complete the recording interval time setting;
- d. Click **Cancel** button or click other part outside the setting box to cancel the current setting value.



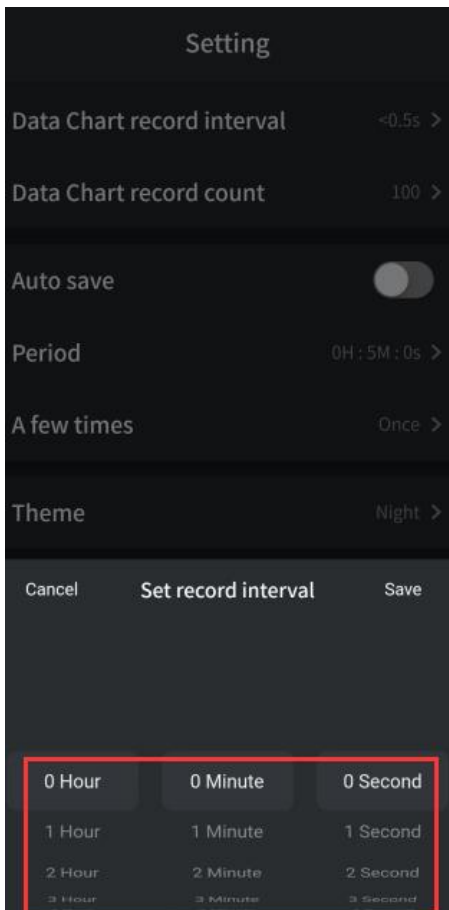

### 3. Setting Data Chart record count

- a. Set the number of recorded data in the real-time recording interface, and then the data will be saved and displayed on the real-time recording interface according to the set number of records;
- b. Click **Data Chart record count** button, and set the number of real-time data records in the display box below (setting range: 100-3000);
- c. After setting the number of records, click **Save** button to complete the setting of the number of real-time data records;
- d. Click **Cancel** button or click other part outside the setting box to cancel the current setting value.

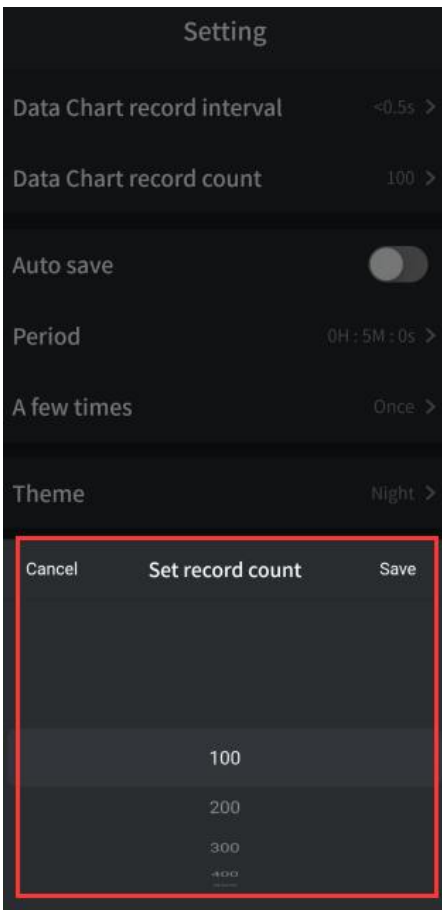

4. **Auto save:** The automatic storage function is to save the data of the real-time data interface according to a fixed period. If a device is being connected, the automatic storage function can be enabled, or else the automatic storage function cannot be enabled. Besides, the automatic storage function is automatically enabled when all the devices are disconnected.

ON-State

OFF-State

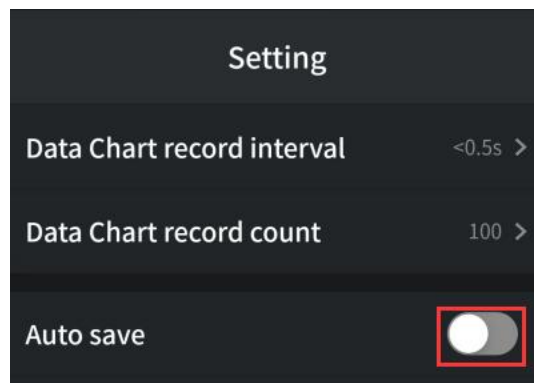
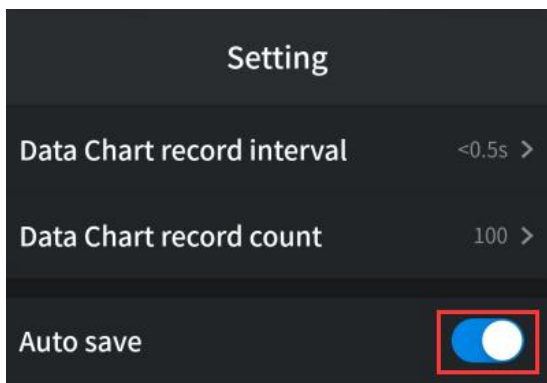

## 5. Setting Periodic

- Before the automatic storage function is enabled, the automatic storage cycle can be set. When automatic storage is enabled, the real-time data storage tasks will be executed according to this cycle.
- Click **“Periodic”** button and set the recording cycle in the display box below (setting range: 1s~ 11h: 59m: 59s).
- After setting the cycle, click **Save** button to complete the setting of the recording cycle of real-time data.

- d. Click **Cancel** button or click other part outside the setting box to cancel the current setting value.

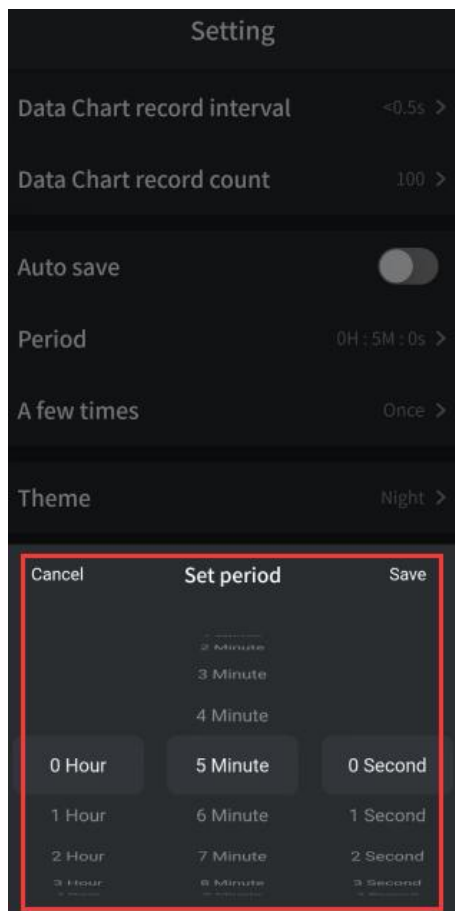

## 6. Setting A few times

- a. The number of automatic storages can be set before the automatic storage function is enabled. After automatic storage is enabled, the real-time data storage task will be executed according to this set. When the task is completed, the automatic storage function will be disabled automatically (for example, when the number of storages is set to 10, the automatic storage function will be disabled when ten groups of real-time data are stored);
- b. Click **“A few times”** button and set the number of storages in the display box below (setting range: Once &10&20&30);
- c. After setting the number of storages, click **Save** button to complete the number setting of the real-time data storage;
- d. Click **Cancel** button or click other part outside the setting box to cancel the current setting value.

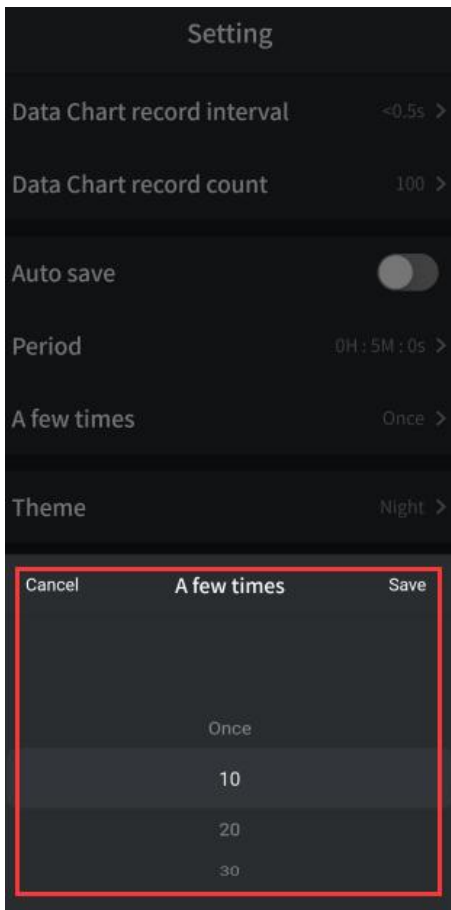

7. **Theme:** Set the theme of the current device, **Night** theme or **Day** theme, and then click “**Save**” button.
8. **About:** Click this button to view the information about the instrument.
9. **Exit:** Click this button to quit the current APP.

## VIII. Technical Specifications

Basic conditions: Ambient temperature: 18 °C~28 °C; relative humidity: not more than 80%.

Note: During AC voltage/ current and capacitance measurement, the measurement accuracy shall be from 5% to 100% range.

Basic Function		Range	Minimum Resolution	Accuracy	
DC Voltage(V)	V	200.00mV	0.01mV	±(0.7%+10dig)	
		2.0000V	0.0001V	±(0.5%+5dig)	
		20.000V	0.001V		
		200.00V	0.01V		
		600.0V	0.1V		
AC	V	2.0000V	0.0001V	VRMS	±(0.8%+10dig)

<b>Voltage(V)</b>		20.000V	0.001V	frequency range: 40Hz-1000 Hz	VFC mode± (4%+3)
		200.00V	0.01V		
		600.0V	0.1V		
<b>DC Current(A)</b>	A	2.0000A	0.001A	±(2%+8dig)	
		20.000A	0.01A	±(2%+3dig)	
		100.00A <sup>[1]</sup>	0.1A		
<b>AC Current(A)</b>	A	2.0000A	0.001A	IRMS frequency range: 40Hz-1000 Hz	±(3%+10dig) VFC mode± (4%+10)
		20.000A	0.01A		±(2.5%+5dig) VFC mode±
		100.00A <sup>[1]</sup>	0.1A		(4%+10)
<b>Resistance (Ω)</b>		200.00Ω	0.01Ω	±(0.8%+10dig)	
		2.0000kΩ	0.0001kΩ	±(0.5%+10dig)	
		20.000kΩ	0.001kΩ		
		200.00kΩ	0.01KΩ		
		2.0000MΩ	0.0001MΩ	±(1%+10dig)	
		20.000MΩ	0.001MΩ		
		200.00MΩ	0.01MΩ	±(5.0%+10dig)	
<b>Capacitance(F)</b>		2.000nF	0.001nF	±(4.0%+10dig)	
		20.00nF	0.01nF	±(3.0%+10dig)	
		200.0nF	0.1nF		
		2.000μF	0.001uF		
		20.00μF	0.01uF		
		200.0μF	0.1uF		
		2.000mF	0.001mF		
		20.00mF <sup>[2]</sup>	0.01mF		
<b>Frequency (Hz)<sup>[3]</sup></b>		200.00Hz	0.01Hz	±(0.1%+5dig)	
		2.0000kHz	0.0001kHz		
		20.000kHz	0.001kHz		
		200.00kHz	0.01kHz		
		2.0000MHz	0.0001MHz		
		20.000MHz	0.001MHz		
<b>Duty Cycle(%)<sup>[4]</sup></b>		0.1%-99.9%	0.1%	±(1.2%+3dig)	

	(Typical Value:Vrms=1V,f=1kHz)		
	0.1%-99.9%(≥1kHz)		±(2.5%+3dig)

[1]When selecting 2A small current measurement function, read the reading after the display value tends to be stable to ensure the accuracy of the value.

[2]In capacitance measurement mode, if the range of 20.00mF is selected, the measurement time should last for more than 30 seconds.

[3]During the frequency measurement, the typical waveform is rectangular wave or sine wave. The measured signal meets the following conditions:

Frequency	Amplitude (rms)
1Hz–20MHz	≥1V

[4]During the duty cycle measurement, the typical waveform is rectangular wave.

**Note: During resistance and capacitance measurement, it is necessary to consider the effect of the resistance of the test probe on the measured value.**

Characteristics	Description	
Maximum Reading	19999	
Frequency (Hz)	(40-1000)Hz	
Numerical Value Conversion Rate	3 times/second	
Automatic Range	√(Current excluded)	
Opening Sizes	17mm	
True Virtual Value	√	
VFC	√	
Numeric Data Retention	√	
Zeroing Measurement	√	
LCD Backlight	√	
Automatic Shutdown	√	
Buzzer ON/ OFF	√	
NCV function	√	
Low-Voltage Indication	√	
Input Protection	√	
Input Impedance	≥10MΩ	
Over-Range Warm	√	
Bluetooth Communication	CM2100	Without

	CM2100B	√
<b>Battery</b>	3V(1.5V×2)AAA Alkaline battery	
<b>LCD Sizes</b>	40mm*20mm	
<b>Machine Weight</b>	0.19kg	
<b>Machine Dimensions</b>	181.26mm*60.3mm*32mm	
<b>Working Temperature</b>	0℃~40℃	
<b>Storage Temperature</b>	-10℃~60℃	
<b>Relative Humidity</b>	≤80%	
<b>Altitude</b>	Operating: 3,000 meters Non-operating: 15,000 meters	

## IX. Care and Maintenance

**⚠ Warning:** Before opening the back cover of the instrument, make sure that the power supply should be cut off and that the instrument probes have left the input port and the measured circuit.

### 1. Regular Care and Maintenance

\*Please use a damp cloth and gentle cleaning instead of abrasive materials or solvents to clean the instrument housing, do not use.

\*If finding any abnormality in the instrument, immediately stop use it and send it for repair.

\* When the check or repair of the instrument is required, it must be done by the qualified professional maintenance personnel or designated maintenance department.

### 2. Replacement of Battery (see Figure 9)

\*\*When the "⚡" battery undervoltage symbol is displayed on the LCD, the built-in battery must be replaced immediately, otherwise the measurement accuracy will be affected.

\* Battery specification: AAA1.5Vx2 cells

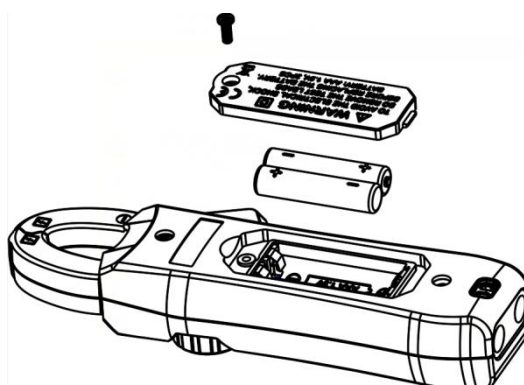

**Figure9**

### Operation Steps:

1. Turn the power switch in the "OFF" position and remove the test probe from the input jack.
2. Unscrew a screw fixing the back cover of the battery with a screwdriver, remove the back cover of the battery, and then remove the old batteries as shown in the figure
3. Replace them with 2 new batteries (specification: AAA1.5V)

## **X. Appendix**

Screwdriver \*1

Test pen \*1

User's Manual \*1

Battery AAA1.5V \*2

The contents of the User's Manual are subject to change without prior notice.