



**FDS Series**  
**User Manual**

For product support, visit: [www.owon.com.hk/download](http://www.owon.com.hk/download)

---

## **Aug. 2023 edition V1.0.4**

Copyright © LILLIPUT Company. All rights reserved.

The LILLIPUT's products are under the protection of the patent rights, including ones which have already obtained the patent rights and those which are applying for. The information in this manual will replace all that in the materials published originally.

The information in this manual was correct at the time of printing. However, LILLIPUT will continue to improve products and reserves the rights to change specification at any time without notice.

**OWON**<sup>®</sup> is the registered trademark of the LILLIPUT Company.

### **Fujian LILLIPUT Optoelectronics Technology Co., Ltd.**

No. 19, Heming Road

Lantian Industrial Zone, Zhangzhou 363005 P.R. China

**Tel:** +86-596-2130430

**Fax:** +86-596-2109272

**Web:** [www.owon.com.cn](http://www.owon.com.cn)

**E-mail:** [info@owon.com.cn](mailto:info@owon.com.cn)

---

# General Warranty

We warrant that the product will be free from defects in materials and workmanship for a period of 3 years from the date of purchase of the product by the original purchaser from our company. The warranty period for accessories such as probes is 12 months. This warranty only applies to the original purchaser and is not transferable to a third party.

If the product proves defective during the warranty period, we will either repair the defective product without charge for parts and labour, or will provide a replacement in exchange for the defective product. Parts, modules and replacement products used by our company for warranty work may be new or reconditioned like new. All replaced parts, modules and products become the property of our company.

To obtain service under this warranty, the customer must notify our company of the defect before the expiration of the warranty period. Customer shall be responsible for packaging and shipping the defective product to our designated service centre, a copy of the customer's proof of purchase is also required.

This warranty shall not apply to any defect, failure or damage caused by improper use or improper or inadequate maintenance and care. We shall not be obligated to furnish service under this warranty a) to repair damage resulting from attempts by personnel other than our company representatives to install, repair or service the product; b) to repair damage resulting from improper use or connection to incompatible equipment; c) to repair any damage or malfunction caused by the use of not our supplies; or d) to service a product that has been modified or integrated with other products when the effect of such modification or integration increases the time or difficulty of servicing the product.

Please contact the nearest sales and service offices for services.

**Excepting the after-sales services provided in this summary or the applicable warranty statements, we will not offer any guarantee for maintenance definitely declared or hinted, including but not limited to the implied guarantee for marketability and special-purpose acceptability. We should not take any responsibilities for any indirect, special or consequent damages.**

# Table of Contents

1. General Safety Requirements .....	1
2. Safety Terms and Symbols .....	3
How to conduct a general inspection .....	5
How to conduct function inspection .....	6
3. Primary User Guide .....	7
A general knowledge of the structure of the instrument .....	8
Front Panel .....	8
Rear Panel .....	9
A general knowledge of the user interface of the instrument .....	10
Power Output Inspection .....	11
How to Implement the Probe Compensation .....	12
How to Set the Probe Attenuation Coefficient .....	13
How to Use the Probe Safely .....	14
How to conduct self-calibration .....	14
4. Use the Android System .....	15
Front Panel Android System Area .....	15
5. Use the Oscilloscope .....	17
A general Knowledge of Oscilloscope .....	17
Front Panel Oscilloscope Area .....	17
A general knowledge of vertical system .....	18
A general Knowledge of Horizontal System .....	19
A general knowledge of Trigger System .....	20
How to use touch screen control .....	20
Use the touch screen to operate the menu .....	20
Operate the touch screen .....	22
Operate the touch screen in waveform amplification mode .....	24
Other touch screen operations .....	25
Advanced User Guide for Oscilloscope .....	28
How to set the vertical system .....	28
How to set horizontal system .....	32
How to set trigger .....	35
How to operate function menu .....	58
How to conduct automatic measurement .....	58
How to conduct collection setting .....	66
How to conduct cursor measurement .....	67
How to realize waveform operation function .....	72
How to set display system .....	74
How to set XY mode .....	76

How to save and print .....	77
How to conduct system function setting .....	89
Oscilloscope .....	89
General .....	104
How to use execution keys .....	107
<b>6. Use Arbitrary Waveform/Function Generator .....</b>	<b>110</b>
Arbitrary waveform/function generator area of front panel .....	110
Display window of arbitrary waveform/function generator .....	110
Setting Window of arbitrary waveform/function generator .....	111
Connect the output end .....	111
Set the channel .....	112
Set the waveform .....	113
Output Built-in Waveform .....	116
Output Modulation Waveform .....	117
Output Sweep Waveform .....	118
Generate Burst .....	119
<b>7. Use the Power Supply .....</b>	<b>120</b>
Power Supply Area on the Front Panel .....	120
Power Display Window .....	120
Power Setting Window .....	121
Overvoltage/Overcurrent Protection .....	122
<b>8. Use the Multimeter .....</b>	<b>123</b>
Multimeter Area on the Front Panel .....	123
Multimeter Zoom Box .....	123
Multimeter Setting Window .....	124
Measure with Multimeter .....	125
Measure AC or DC Voltage .....	125
Measure AC or DC Current .....	125
Measure the Capacitance .....	127
Measure the Resistance .....	127
On-off Test .....	128
Measure the Diode .....	128
Multimeter Functions .....	128
Reading Hold Mode .....	128
Conduct Relative Value Measurement .....	129
Select Auto/Manual Range .....	130
<b>9. Technical Specifications .....</b>	<b>131</b>
Oscilloscope .....	131
Trigger .....	134
Waveform Generator .....	136

Power Supply .....	139
Multimeter .....	140
General Technical Specifications .....	142
<b>10. Appendix.....</b>	<b>144</b>
Appendix A: Enclosure .....	144
Appendix B: General Care and Cleaning .....	144

# 1.General Safety Requirements

Before use, please read the following safety precautions to avoid any possible bodily injury and to prevent this product or any other connected products from damage. In order to avoid any contingent danger, ensure this product is only used within the range specified.

Only the qualified technicians can implement the maintenance.

To avoid Fire or Personal Injury:

- **Connect the probe correctly.** The grounding end of the probe corresponds to the grounding phase. Please don't connect the grounding end to the positive phase.
- **Use Proper Power Cord.** Use only the power cord supplied with the product and certified to use in your country.
- **Connect or Disconnect Correctly.** When the probe or test lead is connected to a voltage source, please do not connect and disconnect the probe or test lead at random.
- **Product Grounded.** This instrument is grounded through the power cord grounding conductor. To avoid electric shock, the grounding conductor must be grounded. The product must be grounded properly before any connection with its input or output terminal.

**When powered by AC power, it is not allowed to measure AC power source directly, because the testing ground and power cord ground conductor are connected together, otherwise, it will cause short circuit.**

**When powered by battery, the product must ground connection. To avoid electric shock, there must be a ground wire connect between ground and the ground port (on the back of product panel).**

- **Check all Terminal Ratings.** To avoid fire or shock hazard, check all ratings and markers of this product. Refer to the user's manual for more information about ratings before connecting to the instrument.
- **Do not operate without covers.** Do not operate the instrument with covers or panels removed.
- **Use Proper Fuse.** Use only the specified type and rating fuse for this instrument.
- **Avoid exposed circuit.** Do not touch exposed junctions and components when the instrument is powered.
- **Do not operate if in any doubt.** If you suspect damage occurs to the instrument, have it inspected by qualified service personnel before further operations.
- **Use your Oscilloscope in a well-ventilated area.** Make sure the instrument installed with proper ventilation, refer to the user manual for more details.

- **Do not operate in wet conditions.**
- **Do not operate in an explosive atmosphere.**
- **Keep product surfaces clean and dry.**
- When measuring current, turn off the circuit power before connecting the multimeter in the circuit. Remember to place the multimeter in series with the circuit.
- When servicing the multimeter, use only the specified replacement parts.
- Use caution when working above 60 V DC, 30 V AC RMS, or 42.4 V peak. Such voltages pose a shock hazard.
- When using the test leads, keep your fingers behind the finger guards on the test leads.
- Disconnect circuit power and discharge all high-voltage capacitors before testing resistance, continuity, diodes, or capacitance.
- **Use the proper terminals, function, and range for your measurements.** When the range of the value to be measured is unknown, choose the auto ranging mode. To avoid damages to the multimeter, do not exceed the maximum limits of the input values shown in the technical specification tables.
- Connect the common test lead before you connect the live test lead. When you disconnect the leads, disconnect the live test lead first.
- Before changing functions, disconnect the test leads from the circuit under test.



## 2.Safety Terms and Symbols

### Safety Terms

**Terms in this manual.** The following terms may appear in this manual:



**Warning:** Warning indicates the conditions or practices that could result in injury or loss of life.



**Caution:** Caution indicates the conditions or practices that could result in damage to this product or other property.

**Terms on the product.** The following terms may appear on this product:









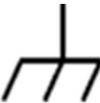
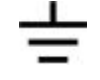

**Danger:** It indicates an injury or hazard may immediately happen.

**Warning:** It indicates an injury or hazard may be accessible potentially.

**Caution:** It indicates a potential damage to the instrument or other property might occur.

### Safety Symbols

**Symbols on the product.** The following symbol may appear on the product:

	Hazardous Voltage		Protective Earth Terminal
	Chassis Ground		Test Ground
	Direct current (DC)		Fuse
	Alternating current (AC)		Caution, risk of danger (refer to this manual for specific Warning or Caution information)
	Both direct and alternating current	<b>CAT II</b>	Category II overvoltage protection
	Conforms to European Union directives	<b>CAT III</b>	Category III overvoltage protection
	Equipment protected throughout by double insulation or reinforced insulation	<b>CAT IV</b>	Category IV overvoltage protection

To avoid body damage and prevent product and connected equipment damage, carefully read the following safety information before using the test tool. This product can only be used in the specified applications.



**Warning:**

The two channels of the oscilloscope are not electrically isolated. The channels should adopt a common ground during measuring. To prevent short circuits, the 2 probe grounds must not be connected to 2 different non-isolated DC levels.



**Warning:**

Note when measuring the channel to the public base, otherwise may cause short circuit because of the oscilloscope probe ground wire.

The diagram of the oscilloscope ground wire connection:

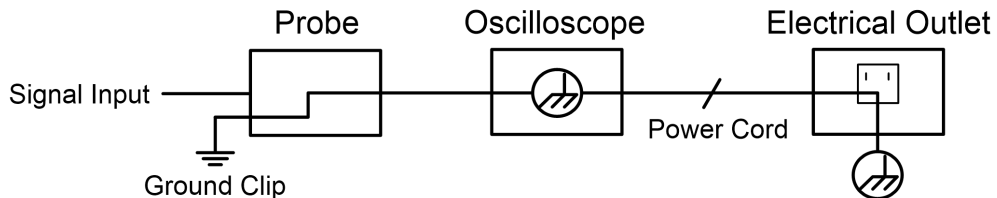

The diagram of the ground wire connection when the battery-powered oscilloscope is connected to the AC-powered PC through the ports:

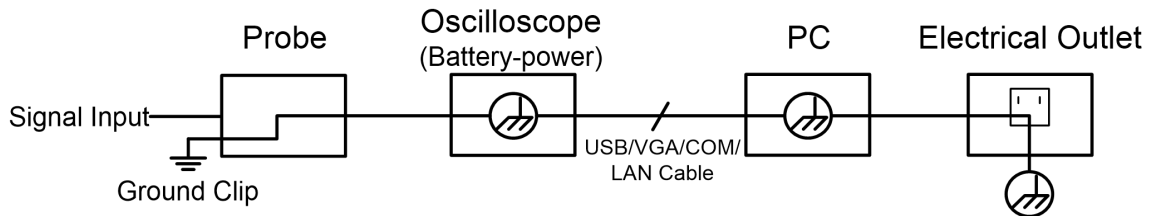

It is not allowed to measure AC power when the oscilloscope is AC powered, or when the battery-powered oscilloscope is connected to the AC-powered PC through the ports.



### **Warning:**

To avoid fire or electrical shock, when the oscilloscope input signal connected is more than 42V peak (30Vrms) or on circuits of more than 4800VA, please take note of below items:

- Only use accessory insulated voltage probes and test lead.
- Check the accessories such as probe before use and replace it if there are any damages.
- Remove probes, test leads and other accessories immediately after use.
- Remove USB cable which connects oscilloscope and computer.
- Do not apply input voltages above the rating of the instrument because the probe tip voltage will directly transmit to the oscilloscope. Use with caution when the probe is set as 1:1.
- Do not use exposed metal BNC or banana plug connectors.
- Do not insert metal objects into connectors.

## **How to conduct a general inspection**

After you get a new device, it is recommended that you should make a check on the instrument according to the following steps:

### **1. Check whether there is any damage caused by transportation.**

If it is found that the packaging carton or the foamed plastic protection cushion has suffered serious damage, do not throw it away first till the complete device and its accessories succeed in the electrical and mechanical property tests.

### **2. Check the Accessories**

The supplied accessories have been already described in the "Appendix A: Enclosure" of this Manual. You can check whether there is any loss of accessories with reference to this description. If it is found that there is any accessory lost or damaged, please get in touch with our distributor responsible for this service or our local offices.

### **3. Check the Complete Instrument**

If it is found that there is damage to the appearance of the instrument, or the instrument can not work normally, or fails in the performance test,

please get in touch with our distributor responsible for this business or our local offices. If there is damage to the instrument caused by the transportation, please keep the package. With the transportation department or our distributor responsible for this business informed about it, a repairing or replacement of the instrument will be arranged by us.

### **How to conduct function inspection**

Conduct a quick function inspection to confirm if the instrument is running in normal state.

#### **Power-on Inspection**

**To power on the instrument, long press  in the lower left of the host.**

The instrument screen shows the startup screen, will display Android screen and wait a few seconds, the relay in the host will make a slight click sound. After performing all self-inspection items on the instrument, the instrument will directly enter instrument system.

## **3.Primary User Guide**

**This chapter elaborates the following topics:**

- **A general knowledge of the structure of the instrument**
- **A general knowledge of the user interface of the instrument**
- **How to conduct probe compensation**
- **How to set the probe attenuation coefficient**
- **How to use the probe safely**
- **How to conduct self-calibration**

## A general knowledge of the structure of the instrument

This chapter gives a brief description and introduction to the operations and functions of the front panel of the instrument, so as to facilitate your operations of the instrument in the shortest time.

### Front Panel

On the instrument panel, knobs and function buttons are used to set different options for current menu, and other buttons are used to enter different function menus or directly obtain specific function application.

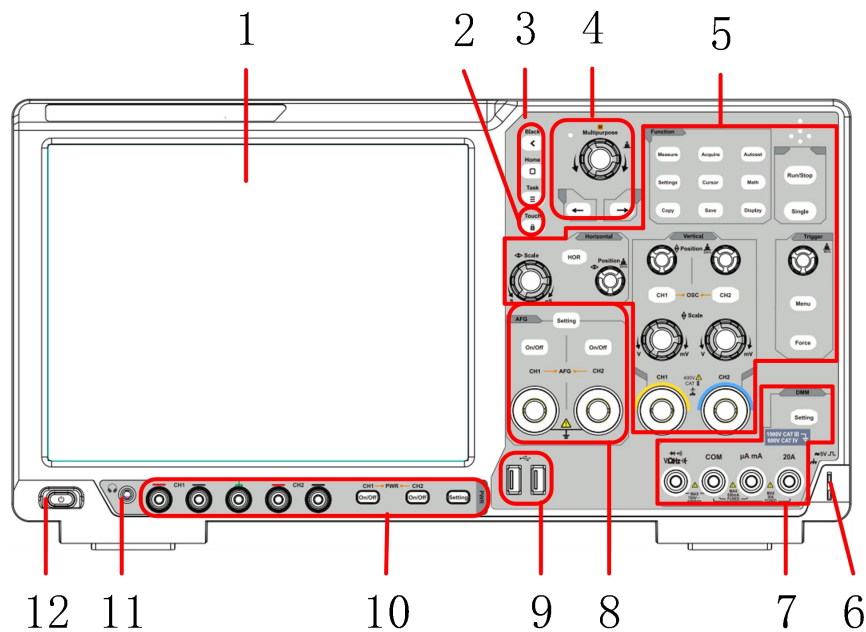

Figure 3- 1 Front panel

1. Display area.
2. Touch key.
3. Android function keys.
4. General knob and arrow keys.
5. Oscilloscope key and knob control area.
6. Probe compensation: 5V/1kHz signal output.
7. Multimeter keys and port control area.
8. Signal generator key and port control area.
9. **USB Host** Interface: When the oscilloscope is connected to an external USB device as a “master device”, the USB Host interface is used to transmit the data.
10. Power key and output port control area.
11. Headphone socket.
12. Instrument switch with memory (self-lock) switch and auto memory of last shutdown; if the instrument is shut down by powering the supply off, there is no need to press the switch to start it up after next power-on; if the instrument is shut down by pressing the switch key, it is required to press

the switch key again to power it on.

## Rear Panel

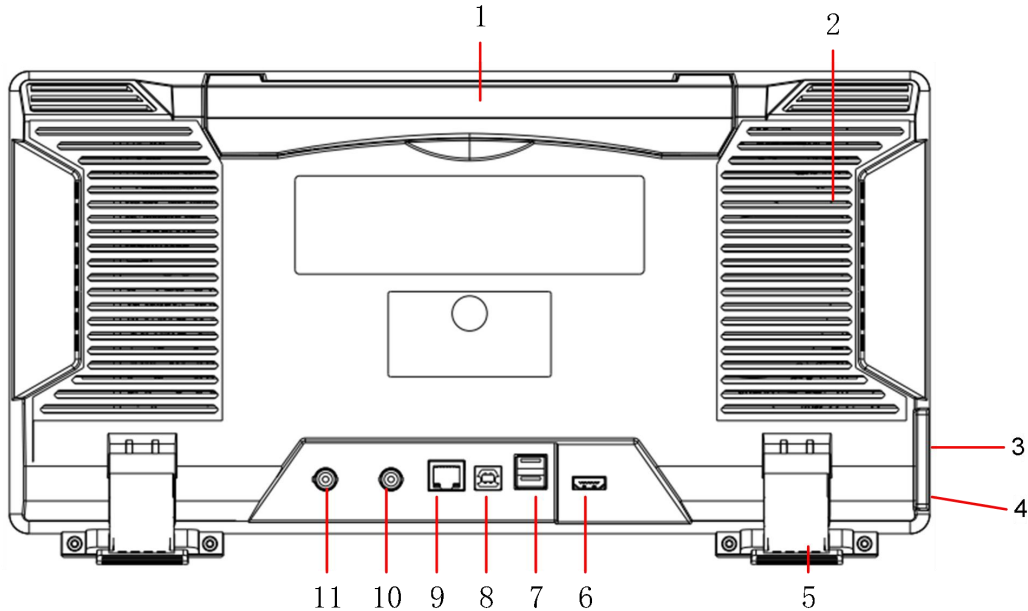

Figure 3-2:Rear Panel

1. **Foldable Handle.**
2. **Heat Emission Hole.**
3. **Power Outlet.**
4. **Fuse.**
5. **Foot Rest:** To adjust the inclined angle of the oscilloscope.
6. **HDMI Interface:** To connect HDMI output to the external monitor or projector.
7. **USB Host Interface:** When the oscilloscope is connected to an external USB device as a “master device”, the USB Host interface is used to transmit the data.
8. **USB Device Interface:** When the oscilloscope is connected to an external USB device as a “slave device”, the USB Device interface is used to transmit the data. For example, use the interface to connect a PC or printer.
9. **LAN Interface:** The network interface to connect a PC or router.
10. **External Trigger Input Interface (EXT Trig In).**
11. **Trig Out (P/F) Interface:** Trigger output or pass/fail output port.

## A general knowledge of the user interface of the instrument

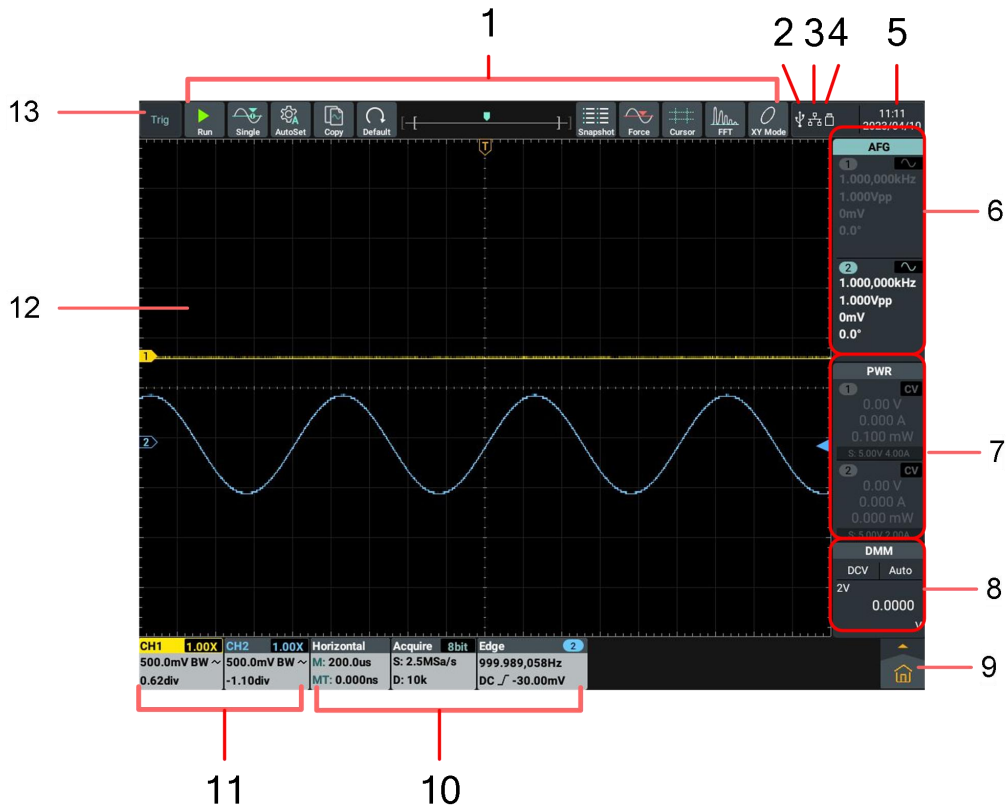



Figure 3-3: Illustrative Drawing of Display Interfaces

1. Shortcut soft keys of oscilloscope functions.
2. It indicates that a USB Device cable is inserted currently.
3. It indicates that a network cable is connected, that is, the LAN port is accessed (If icon for the , it indicates the Wi-Fi is enabled and connected currently).
4. It indicates that a USB flash drive is inserted currently.
5. Display the system set time.
6. Display window of signal generator.
7. Power display window.
8. Multimeter display window.
9. Main menu, click to pop up the oscilloscope and general function menu window.
10. Information display bar of oscilloscope horizontal, acquire and trigger functions.
11. Information display bar of oscilloscope channel.
12. Waveform display area.
13. Display current operating status.



## Oscilloscope Inspection

1. **Set the Switch in the Oscilloscope Probe as 10X and Connect the Oscilloscope with CH1 Channel.**

Align the slot in the probe with the plug in the CH1 connector BNC, and then tighten the probe with rotating it to the right side.

Connect the probe tip and the ground clamp to the connector of the probe compensator.

2. **Push the Autoset Button at the top left of the screen or on the front panel.**

The square wave of 1 kHz frequency and 5V peak-peak value will be displayed in several seconds (see Figure 3-4).

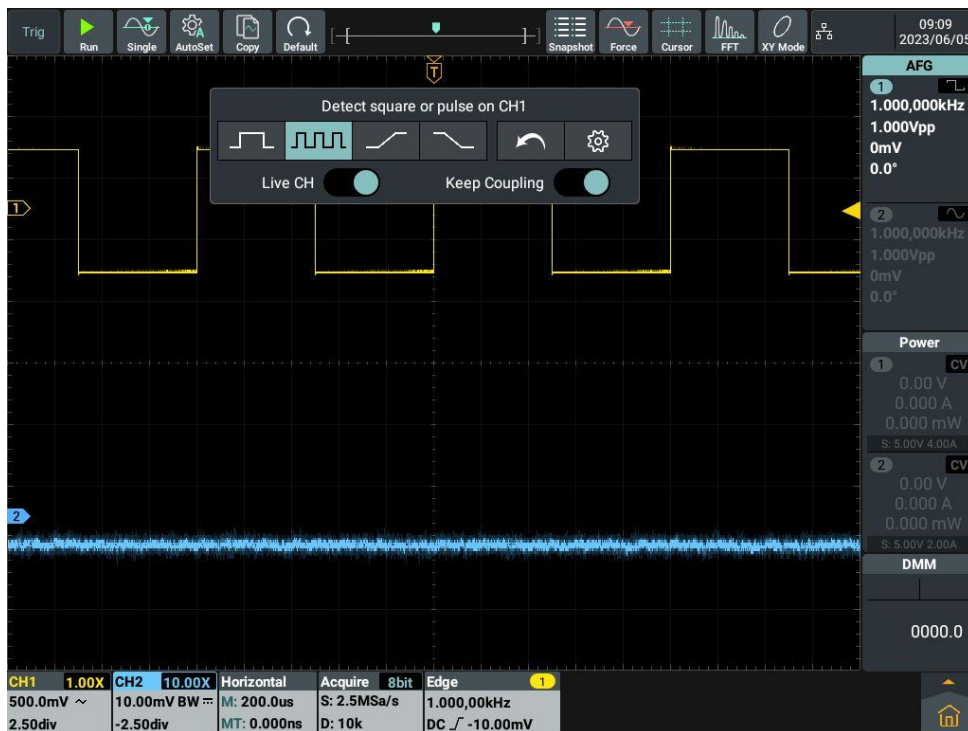

Figure 3-4:Auto set

Check CH2 by repeating Step 2 and Step 3.

## Power Output Inspection

Output inspection is to ensure that the instrument can achieve its rated outputs and properly respond to operation from the front panel.

### 1. Voltage Output Inspection

- (1) When the instrument is under no load, select a channel and ensure the output current setting for this channel is not at zero.

- (2) Turn on the channel output, then ensure the channel is in Constant Voltage output mode.
- (3) Set some different voltage values on this channel; check if the actual voltage value displayed is close to the set voltage value, and also that the actual current value displayed is nearly to zero.
- (4) Check CH1 and CH2 channel if the output voltage can be adjusted from 0.1V to the maximum rating.

## 2. Current Output Inspection

The following steps check basic current functions with a short across the power supply's output:

- (1) Power on.
- (2) Connect a short across (+) and (-) output terminals with an insulated test lead on this channel. Use a wire size sufficient to handle the maximum current.
- (3) Set the output voltage to the maximum rating on this channel.
- (4) Turn on the channel output. Ensure the channel you used is in Constant Current output mode.
- (5) Set some different current values on this channel; check if the actual current value displayed is close to the set current value, and to check if the actual voltage value displayed is nearly zero.
- (6) Check CH1 and CH2 channel if the output current can be adjusted from zero to the maximum rating, When it is set to the maximum or minimum, a beep is heard, indicating that the limit has been reached.
- (7) Turn off the channel output and remove the short circuit from the output terminals.

## How to Implement the Probe Compensation

When connect the probe with any input channel for the first time, make this adjustment to match the probe with the input channel. The probe which is not compensated or presents a compensation deviation will result in the measuring error or mistake. For adjusting the probe compensation, please carry out the following steps:

1. Set the attenuation coefficient of the probe in the menu as 10X and that of the switch in the probe as 10X (see "*How to Set the Probe Attenuation Coefficient*" on P13), and connect the probe with the CH1 channel. If a probe hook tip is used, ensure that it keeps in close touch with the probe. Connect the probe tip with the signal connector of the probe compensator and connect the reference wire clamp with the ground wire connector of

the probe connector, and then push the **Autoset** button on the front panel.

2. Check the displayed waveforms and regulate the probe till a correct compensation is achieved (see Figure 3-5 and Figure 3-6).

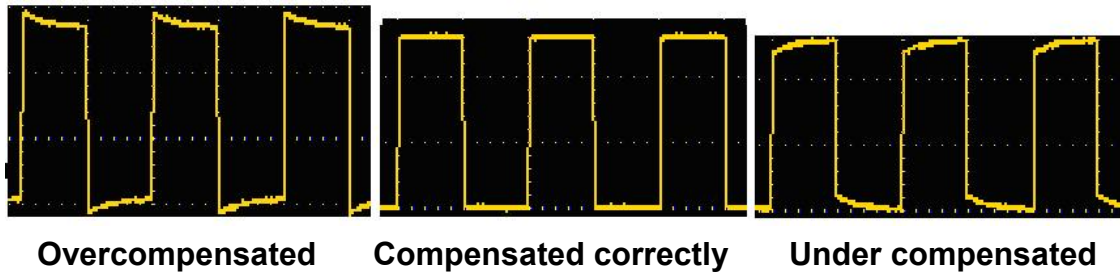

Figure 3-5 Displayed Waveforms of the Probe Compensation

3. Repeat the steps mentioned if needed.

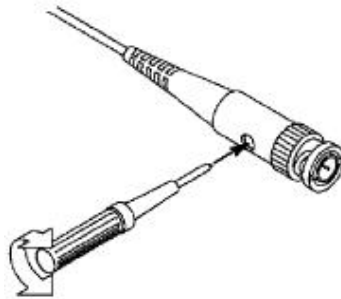

Figure 3-6 Adjust Probe

## How to Set the Probe Attenuation Coefficient

The probe has several attenuation coefficients, which will influence the vertical scale factor of the oscilloscope.

To change or check the probe attenuation coefficient in the menu of oscilloscope:

- (1) Push the function menu softkey of the used channels (**CH1** channel or **CH2** channel).
- (2) Select **Probe Attenu** (**1X** , **10X** or other custom probe magnifications) in the displayed channel setting window. The setting will remain in effect until changed again after selection

This setting will be valid all the time before it is changed again.



### Caution:

The default attenuation coefficient of the probe on the instrument is preset to 10X.

Make sure that the set value of the attenuation switch in the probe is the same as the menu selection of the probe attenuation coefficient in the oscilloscope.

The set values of the probe switch are 1X and 10X (see *Figure 3-7*).



Figure 3-7 Attenuation Switch



**Caution:**

When the attenuation switch is set to 1X, the probe will limit the bandwidth of the oscilloscope in 5MHz. To use the full bandwidth of the oscilloscope, the switch must be set to 10X.

---

## How to Use the Probe Safely

The safety guard ring around the probe body protects your finger against any electric shock, shown as *Figure 3-8*.

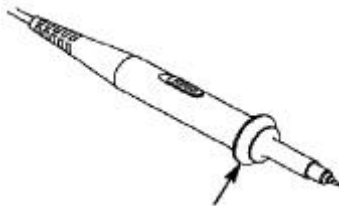

Figure 3-8 Finger Guard



**Warning:**

To avoid electric shock, always keep your finger behind the safety guard ring of the probe during the operation.

To protect you from suffering from the electric shock, do not touch any metal part of the probe tip when it is connected to the power supply.

Before making any measurements, always connect the probe to the instrument and connect the ground terminal to the earth.

---

## How to conduct self-calibration

Self-calibration program is used to quickly make the oscilloscope be in the optimum condition to obtain the most accurate measurement. This program can be performed at any time. It is especially necessary when the ambient temperature reaches or exceeds 5°C.

To conduct self-calibration, disconnect all probes and wires from the input connector. Then, press **Settings** key at the oscilloscope area of the front panel or click “” in the lower right of the screen, select **Oscilloscope** from the right menu and **Self-calibration** from the menu displayed, and click **Start** in the self-calibration display box.

## 4.Use the Android System

### Front Panel Android System Area

Four keys are contained at the front panel area of the instrument. They are **Back, Home, Task** and **Touch**.

**Note:** The Touch Lock is only available in Edulnstr system and does not work on the main homepage and other application interface.



### Android System Homepage Window

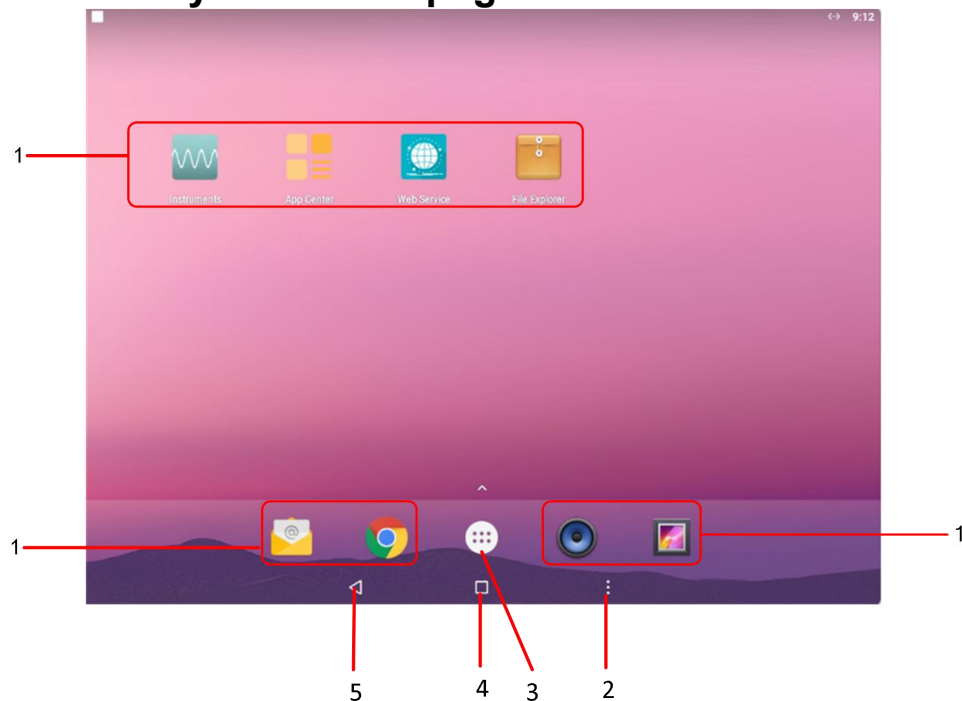

1. Application shortcut key
2. Task key
3. App Drawer (Click to see all apps)
4. Home key
5. Back key

## System built-in application list

Open the application drawer of the main page. There are 17 built-in applications in the system, including: App Center, Calculator, Calendar, Chrome, Browser, Clock, Email, File Explorer, Gallery, Instruments, Music, Pydroid3, Screen Recorder, Settings, Sound Recorder, USB Camera, Web Service and WPS Office, as illustrated in the figure below:

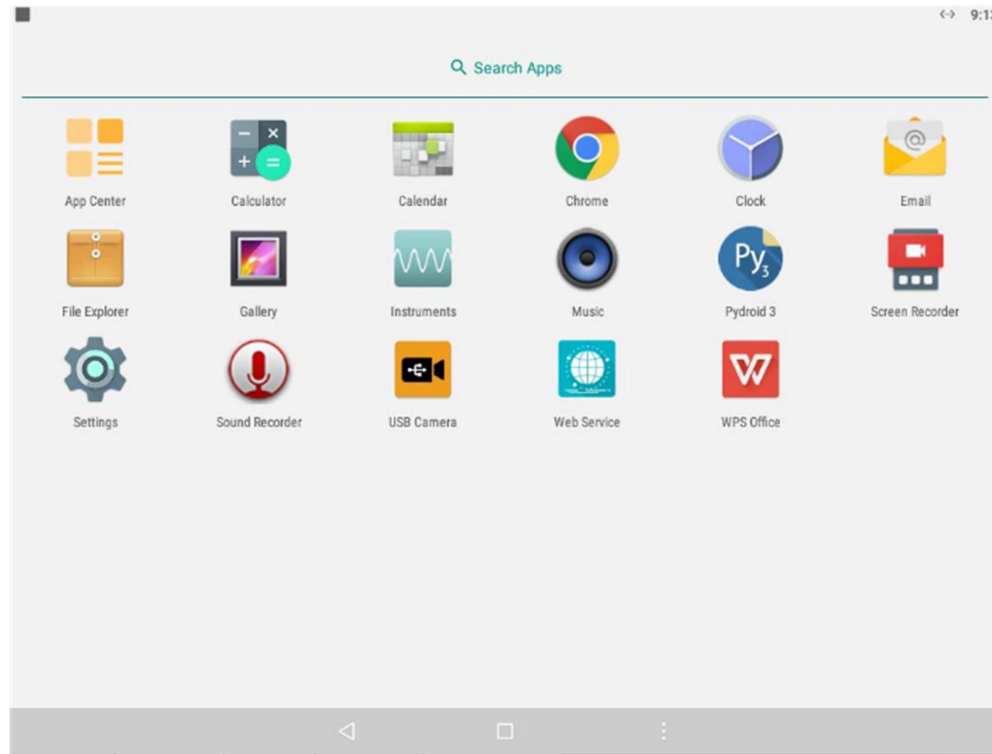

## 5. Use the Oscilloscope

### A general Knowledge of Oscilloscope

#### Front Panel Oscilloscope Area

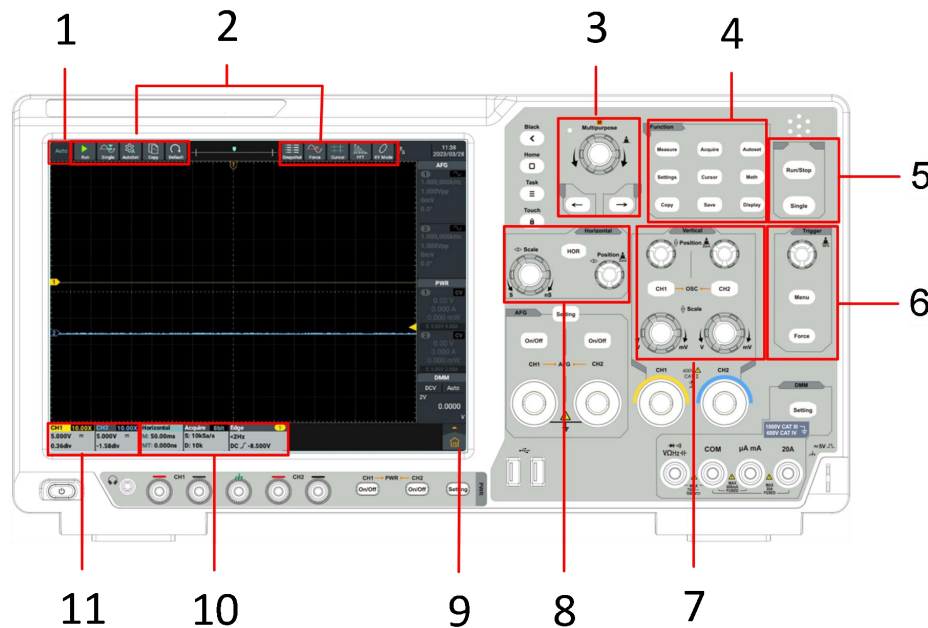

#### Instructions:

1. Trigger state.
2. Oscilloscope function shortcut keys.
3. General knob and arrow keys.  
**General knob:** When **M** appears in the screen menu, it indicates that the **General** knob can be turned to select current menu or set the value.  
**Arrow keys:** Move to select the parameter.
4. **Function key area:** There are 9 keys in total.
5. **Shortcut key:** Run/Stop, Signal.
6. **Trigger control area:**  
 Contain two keys and one knob.  
 “Trigger Level” knob is to adjust the trigger level.  
 Menu button correspond to the settings of the trigger system;  
 Force button is the forced trigger shortcut button.
7. **Vertical control area:**  
 Contain two keys and four knobs.  
 In the oscilloscope state, the “CH1” key and “CH2” key correspond to the channel switch of Channel 1 and Channel 2, respectively. Two “Vertical Displacement” knobs are to control the vertical displacement of Channel 1 and Channel 2, respectively. And two “Gear” knobs are used to control the voltage of Channel 1 and Channel 2, respectively

8. **Horizontal control area:**

Contain one key and two knobs.



In the oscilloscope state, the “Horizontal Menu” key corresponds to the setup menu of the horizontal system, the “Horizontal Displacement” knob is to control the horizontal displacement triggered, when pressing the knob horizontal displacement can be zero and the “Gear” knob is used to control the time base gear.

9. Main menu button: Click to display/hide the main menu, including the oscilloscope and general function menu list.

10. Oscilloscope function information box: Display horizontal, acquisition, and trigger information content separately. Click to display/hide corresponding function setting window.

11. Vertical channel information box: Display the configuration information content of channel 1 and channel 2 respectively. The information content includes: channel switch, voltage gear, zero position, bandwidth limit, etc. In the display content, BW indicates that the bandwidth limit is 20MHz.

The icon indicates the coupling mode of the channel:

- “” indicates DC coupling
- “” indicates AC coupling
- “” indicates ground coupling

## A general knowledge of vertical system

As shown in Figure 5-1, there are two buttons and four knobs in the Vertical Control Area. The following exercises are to guide you through the use of the vertical settings.

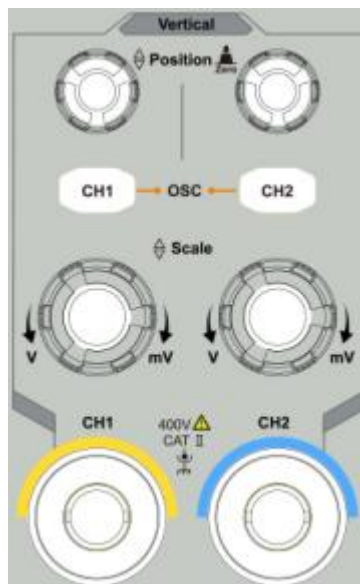

Figure 5- 1: Vertical Control Area

1. Press the **Vertical Displacement** knob to center display the signal in the waveform window. It is used to control the vertical display position of the signal. When turning the **Vertical Displacement** knob, the



pointer indicating the **Grounding Reference Point** of the channel moves up and down following the waveform. When press the **Vertical Displacement** button, the vertical displacement can be zero.

### Measuring Skills

If the DC coupling mode is adopted for the channel, observe the gap between the waveform and the signal ground to quickly measure the DC component of the signal.

If the AC coupling mode is adopted for the channel, the DC component of the signal is filtered out, facilitating you to display the AC component of the signal with higher sensitivity.

2. Change the vertical settings and observe the resulting status change. You can determine the change of the vertical gear factor of any channel through the information displayed in the status bar at the lower part of the waveform window.

- Turn the **Vertical Gear** knob to change the **Vertical Gear Factor (Voltage Gear)**, and the gear factor of corresponding channel in the status bar changes accordingly.

3. Press the **CH1** and **CH2** key to enable or disenable corresponding channel.

## A general Knowledge of Horizontal System

As shown in Figure 5-2, there is a key and two knobs in the **Horizontal Control Area**. The following exercises are to guide you through the use of the horizontal time base settings.

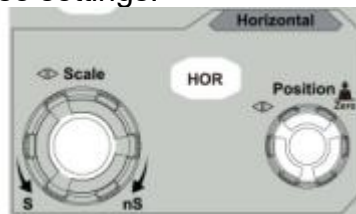

Figure 5- 2:Horizontal Control Area

1. Turn the **Horizontal Gear** knob to change the settings of the horizontal time base and thus observe the resulting change of the status information, then the corresponding **Horizontal Time Base** in the status bar changes accordingly.

Press the **Horizontal Gear** knob enter or exit waveform amplification mode.

2. Turn the **Horizontal Displacement** knob to adjust the horizontal displacement of the signal in the waveform window.

3. The **Horizontal Displacement** knob is to control the triggered horizontal displacement of the signal; when turning the knob, the waveform moves horizontally with the knob. When press the **Horizontal Displacement** button, the horizontal displacement can be zero.

4. Press the **HOR** key to pop up the horizontal Settings window.

## A general knowledge of Trigger System

As shown in Figure 5-3, there is a knob and two keys in the **Trigger Control Area**. The following exercises are to guide you through the settings of the trigger system.



Figure 5-3: Trigger Control Area

1. Press the **Trigger Menu** key to call the trigger menu, and operate the displayed menu to change the trigger settings.
2. Use **Trigger Level** knob to change the settings of the trigger level.  
Turn the **Trigger Level** knob, the trigger pointer on the screen moves up and down as the knob turns. While moving the trigger pointer, the value of the trigger level on the screen changes accordingly.  
**Note:** Turning the **Trigger Level** knob can not only change the trigger level value, but also set the shortcut key of the trigger level at the vertical midpoint of the trigger signal amplitude.
3. Press **Forced Trigger** key to generate a trigger signal forcibly, mainly used in the “Normal” and “Single” trigger mode.

## How to use touch screen control

The touch screen can be used to control the oscilloscope by various gestures. Operate the touch screen when the light of the touch lock in the upper left of the front panel is off; click the key to light up the indicator; the touch function is disabled when the touch lock is in locked state.

The instructions of the touch screen operations are as follows, the contents in the parentheses indicate the key or knob that plays the same role.

### Use the touch screen to operate the menu

- **Open the Settings window function:** Directly click menu items in the lower menu bar or the right menu bar of the display area to pop up the setting window of the corresponding function.
- **Set Menu Item:** In the Settings window, you can change the configuration of the relevant menu item by touching it. The types of operable parts include: switch, button, radio, gear hobbing (scrolling list), etc. The

following box selects the radio type, click directly to switch the options.

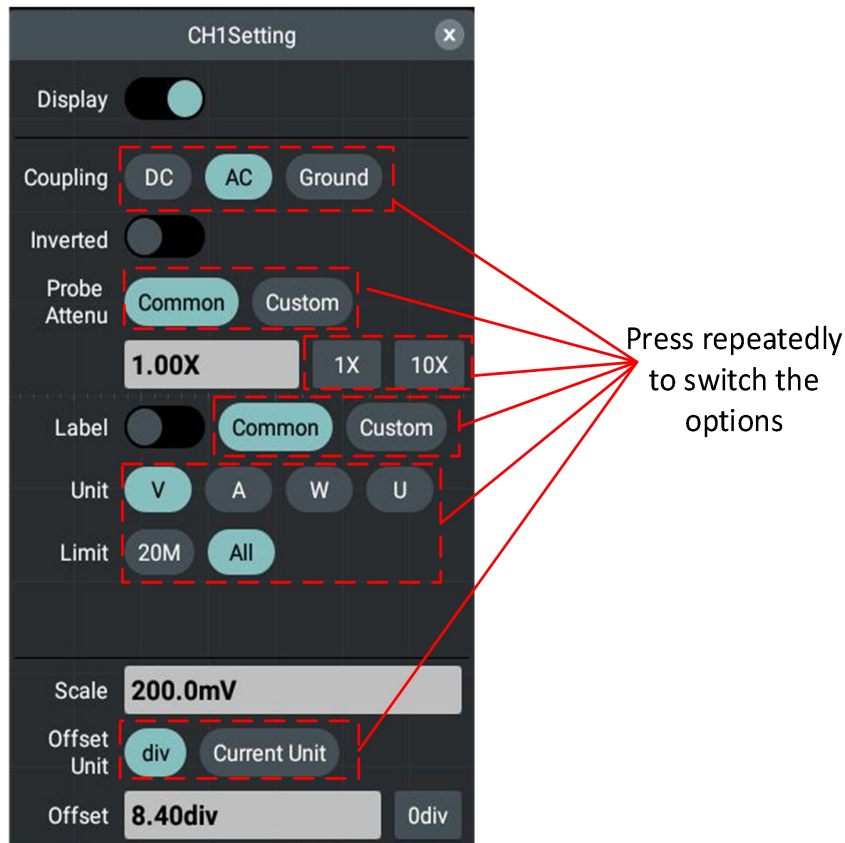

- **Scroll List:** When the scroll bar appears in the menu or file system window, swipe the screen up and down with the finger to scroll the list, as shown in the figure below.



- **Open Main Menu:** Click the  icon in the lower right of the display area, the main menu window pops up, as shown below, with each item corresponding to the keys with the same name on the panel or the shortcut keys at the upper part of the screen. Clicking the item is equivalent to pressing the corresponding key on the panel or the shortcut key at the upper part of the screen.

## 5. Use the Oscilloscope

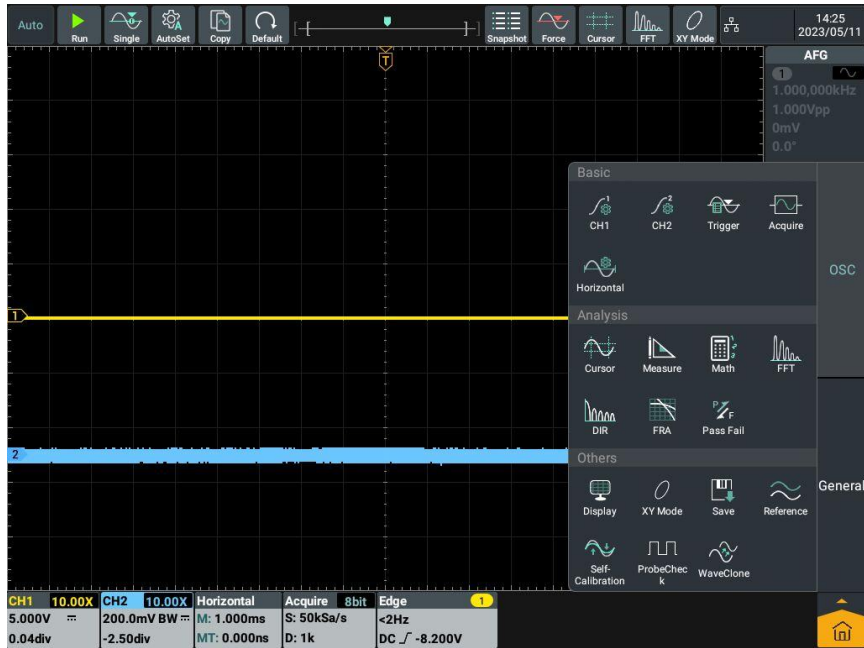

### Operate the touch screen

- **Select a Channel (CH1 channel or CH2 channel):** Click the channel pointer at the left side or the channel waveform to select the channel point.
- **Set the vertical position of the selected channel waveform (Vertical Displacement knob):** Waveform area on the right side of two for trigger level touch mobile area, slide up and down in the area can change the trigger level, as shown in the figure below.

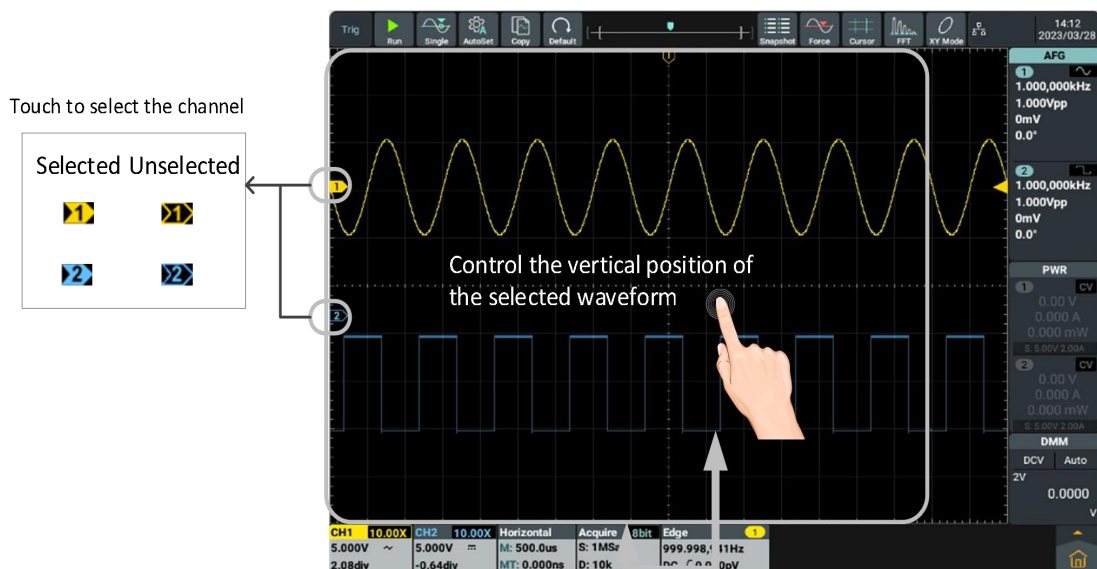

- **Set the trigger level of the signal source in the Trigger Menu (Trigger Level knob):** Swipe the screen up and down with the finger near the trigger area two squares to the right side, as shown in the figure below.

## 5. Use the Oscilloscope

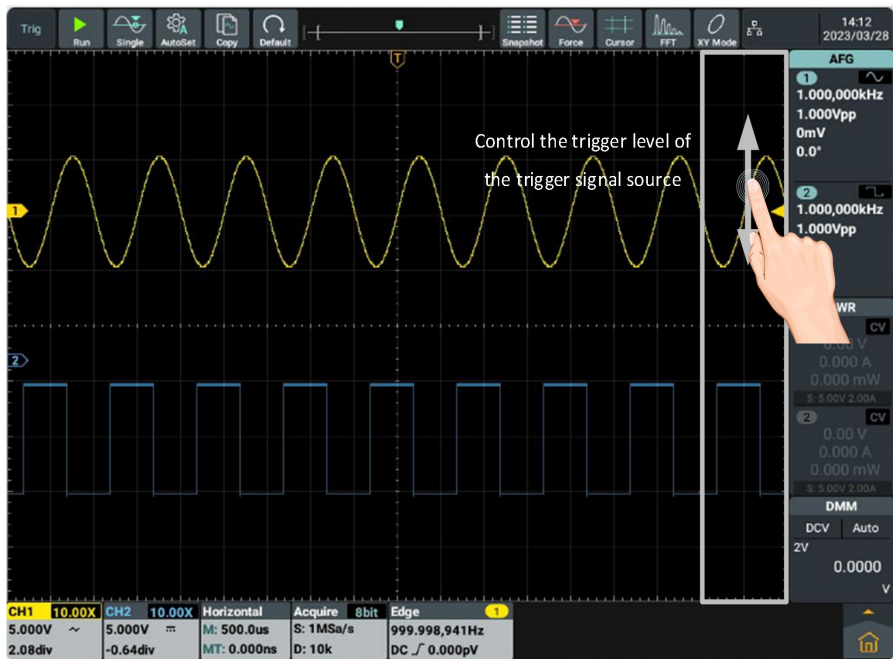

- **Set Horizontal Position (Horizontal Displacement knob):** Swipe the screen left and right with the finger in the waveform display area, as shown in the figure below.

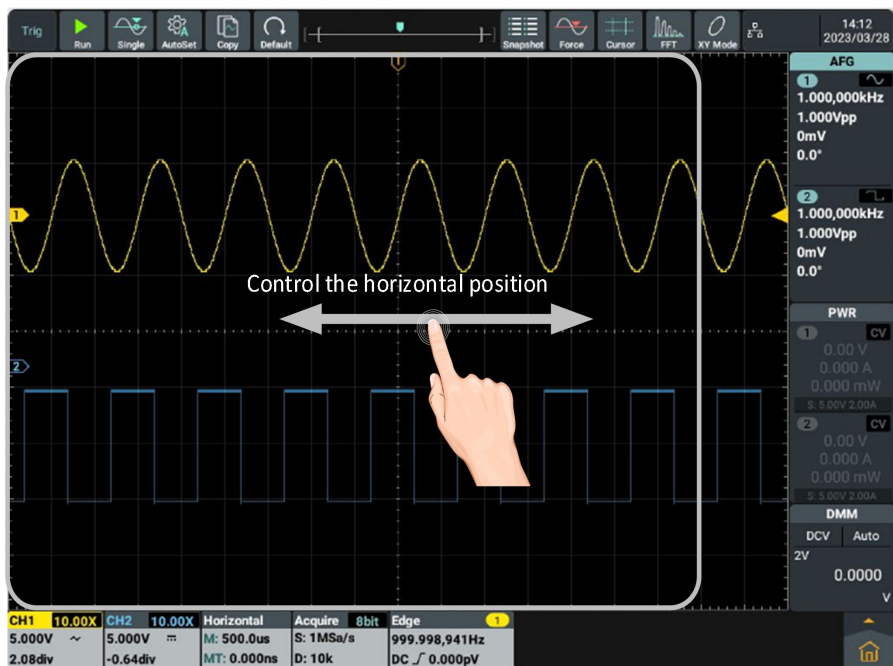

- **Control the voltage gear and time base by pinch action:** Pinch the thumb and the index finger up and down/left and right in the waveform display area, as shown in the figure below.

## 5. Use the Oscilloscope

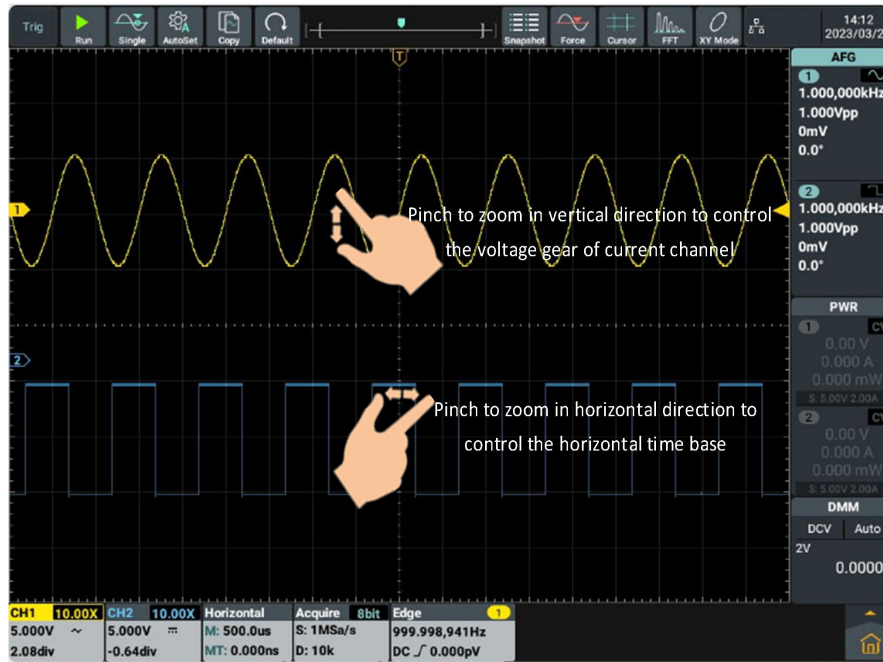

### Operate the touch screen in waveform amplification mode

Press **Horizontal Gear Knob** to enter the waveform amplification mode, the main window is displayed at the top half of the screen and the amplified window is displayed at the bottom half of the screen. The amplified window is the amplified part of the main window that is selected.

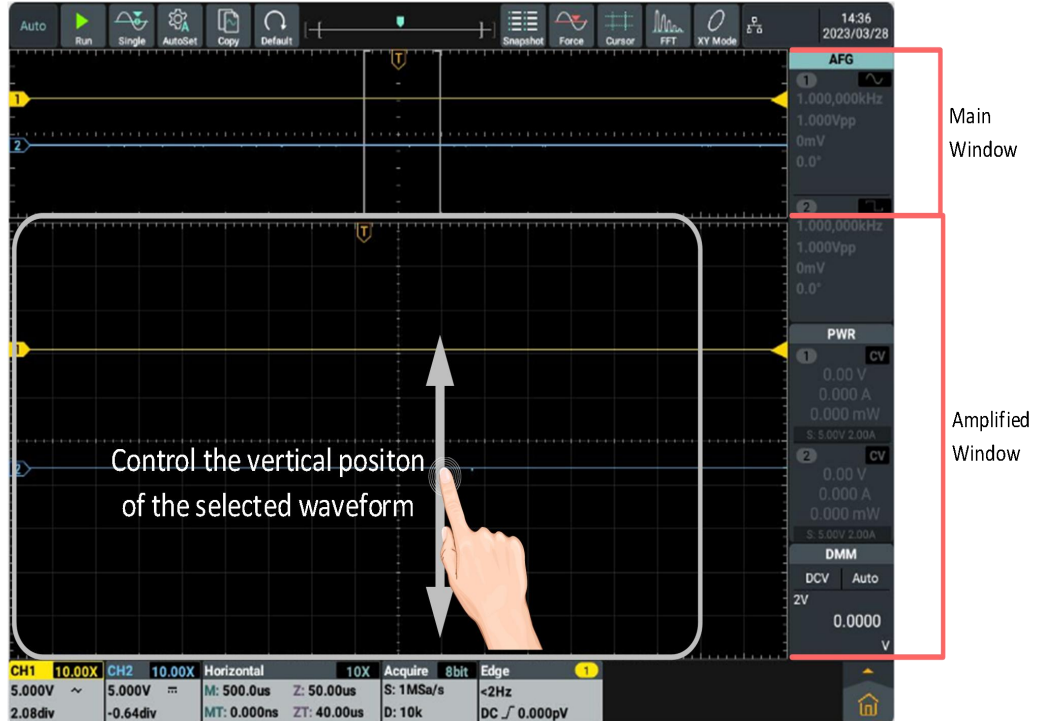

## 5. Use the Oscilloscope

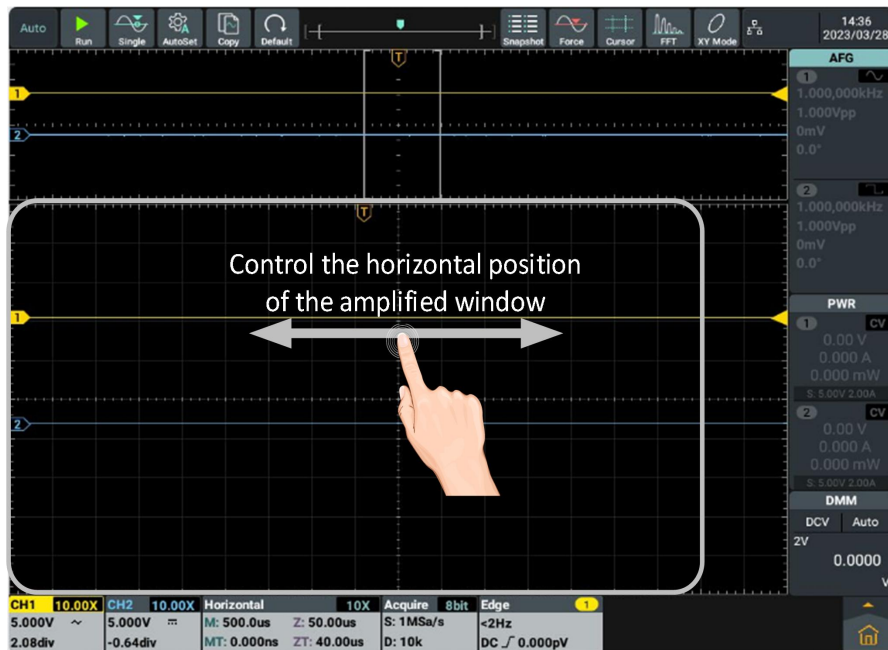



### Other touch screen operations

- Click and drag the open menu item to move itself to the appropriate location.
- Control the horizontal or vertical cursor lines under cursor measurement:

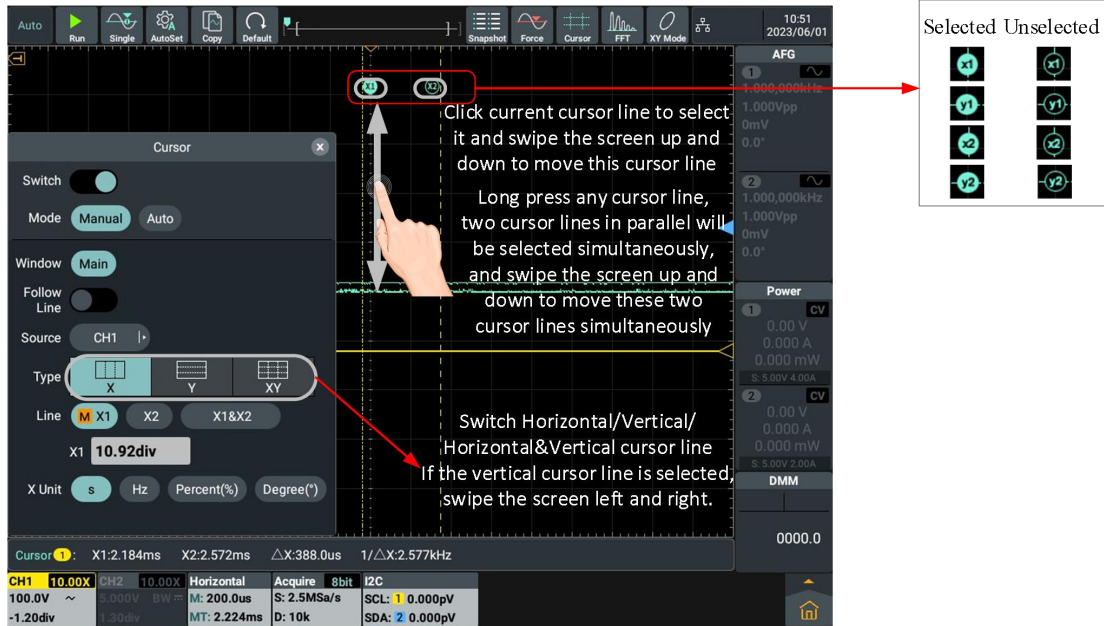
## 5. Use the Oscilloscope



- **Run/Stop:** Click  or  in the upper left of the display area to switch Run/Stop.
- **Parameter Setting Keyboard in Menu Item:** There are digital input mode and gear input mode.

Digital input mode: Click to input.

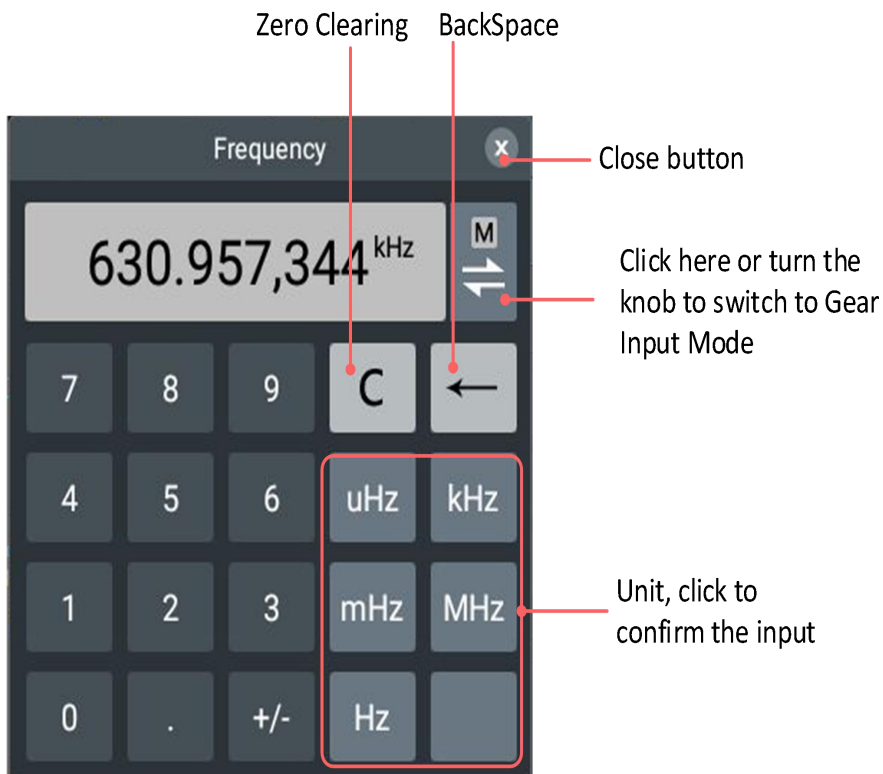

Gear input mode, as shown in the figure below:



## 5. Use the Oscilloscope

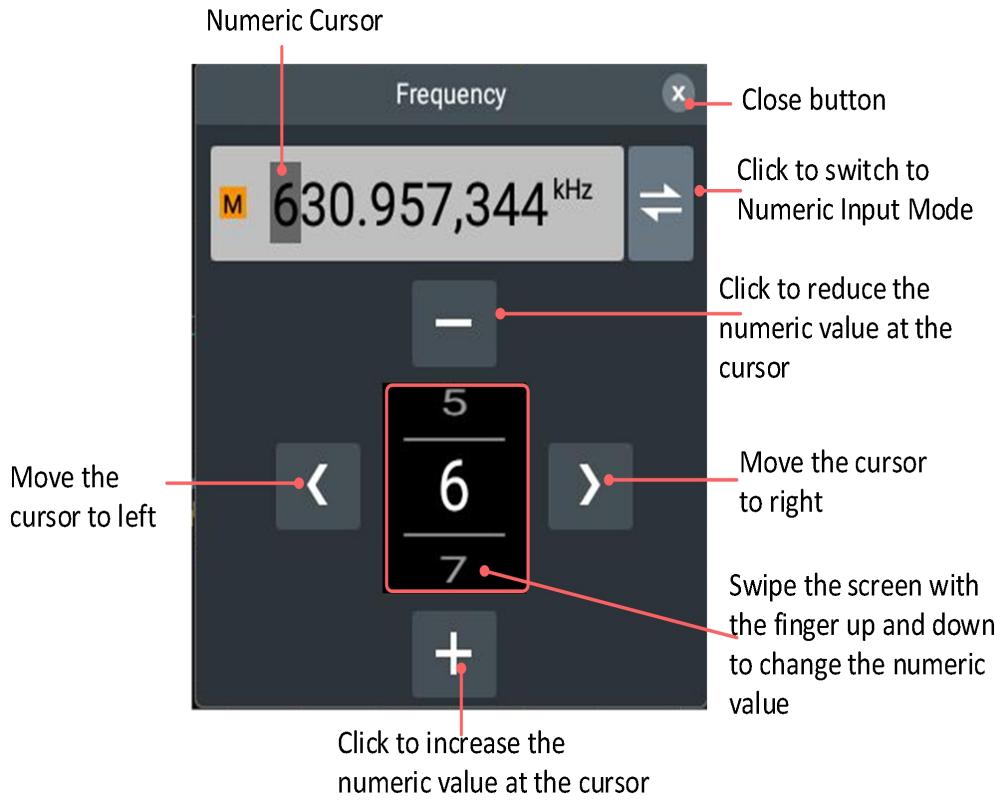

## Advanced User Guide for Oscilloscope

In the previous chapter, basic operations of the oscilloscope, function area of the front panel and the roles of the keys and knobs are introduced for the user to determine the change of instrument settings by observing the status bar. For any details of the operations and methods mentioned above, refer to Chapter 3 “Primary User Guide”

This chapter covers the following contents:

- **How to set the vertical system**
- **How to set the horizontal system**
- **How to set trigger**
- **How to conduct automatic measurement**
- **How to conduct collection settings**
- **How to conduct cursor measurement**
- **How to realize waveform operation function**
- **How to set the display system**
- **How to set XY mode**
- **How to save and print**
- **How to set FFT**
- **How to set DIR(digital filtering)**
- **How to conduct frequency response analysis**
- **How to pass the test setting**
- **How to conduct reference waveform**
- **How to conduct probe check**
- **How to clone and restore waveform**
- **How to use execution keys**

Please carefully read this chapter to understand various measuring functions and other operation methods of the oscilloscope.

### How to set the vertical system

In the vertical system control area, there are two switch keys (**CH1** and **CH2**) and four knobs (two **Vertical Displacement** knobs and two **Vertical Gear** knob for each channel).

## Set Channel 1 and Channel 2

Each channel is equipped with the independent vertical menu, and each item is set separately based on different channel.

### How to open or close the waveform (channel)

Press CH1 and CH2 front panel key to:

- If the waveform is closed, open the waveform.
- If the waveform is open, close the waveform.

### How to open the channel settings

Click the channel Information Box in the lower left of the screen to display the channel setting box.

See the following table for the instructions of Channel Setting Menu:

Function Menu	Settings	Instructions
Display		Click to open/close the channel waveform.
Coupling	DC AC Ground	Pass the AC and DC component of the input signal. Block the DC component of the input signal. Disconnect the input signal.
Inverted		Click to open or close the waveform inversion function.
Probe Attenu	Common	Click the Numeric Display Box and turn General knob or swipe the screen up and down in the numeric select box with the finger to select commonly used magnification; it is also available to set 1X and 10X probe magnification with 1X and 10X keys.
	Custom	Click the Numeric Display Box to set the probe magnification within the range between $1 \times 10^{-6}$ and $1 \times 10^6$ .
Label		Click the switch to the right of the <b>Label</b> item to choose to display or not display the channel label.
	Common	Set a common display label for a channel. Click the label box, adjust the universal knob or swipe up and down in the label selection box with your finger to select some commonly used labels.
	Custom	Click on the channel label input box and enter the string directly through the letter keyboard that pops up.

## 5. Use the Oscilloscope

Unit	V A W U	Set the display unit of current channel as required.														
Limit	ALL 20MHz	The bandwidth of the oscilloscope. Limit to 20MHz to reduce the display noise.														
Scale	<table border="1" style="display: inline-table; vertical-align: top;"> <tr><td>1.000mV</td><td>100.0mV</td></tr> <tr><td>2.000mV</td><td>200.0mV</td></tr> <tr><td>5.000mV</td><td>500.0mV</td></tr> <tr><td>10.00mV</td><td>1.0000V</td></tr> <tr><td>20.00mV</td><td>2.000V</td></tr> <tr><td>50.00mV</td><td>5.000V</td></tr> <tr><td></td><td>10.00V</td></tr> </table>	1.000mV	100.0mV	2.000mV	200.0mV	5.000mV	500.0mV	10.00mV	1.0000V	20.00mV	2.000V	50.00mV	5.000V		10.00V	Select the optimum gear as required. Note: Current unit selection is V and the voltage gear of the probe multiplier is 1X.
1.000mV	100.0mV															
2.000mV	200.0mV															
5.000mV	500.0mV															
10.00mV	1.0000V															
20.00mV	2.000V															
50.00mV	5.000V															
	10.00V															
Offset Unit	div Current Unit	According to requirement to set offset unit.														
Offset		Set the vertical display position of the waveform; due to limited screen display, the visible range is $\pm 5$ div.														

### 1. Set the channel coupling

Taking Channel 1 as an example, the measured signal is a square-wave signal with DC bias, the operating steps are as follows:

- (1) Click **CH1** Information Box to call **CH1 Setting** Menu.
- (2) Click **Display** switch in the menu to highlight it.
- (3) In the **Coupling** menu, select **DC** to set to DC Coupling mode. Both DC and AC components contained in the measured signal can be passed through.
- (4) In the **Coupling** menu, select AC to set to AC Coupling mode. DC components contained in the measured signal will be blocked.

### 2. Set waveform inversion

Waveform inversion: Flip the displayed signal 180 degrees relative to the ground potential.

Taking **Channel 1** as an example, the operating steps are as follows:

- (1) Click CH1 Information Box to call **CH1 Setting** Menu.
- (2) Click **Display** switch in the menu to highlight it.
- (3) In the menu, click **Inverted** switch to highlight it, the waveform inversion will be enabled. Click **Inverted** switch gain to gray it, the waveform inversion will be disabled.

### 3. Adjust Probe Ratio

It is required to adjust the coefficient of the probe attenuation ratio in the channel operation menu (see "How to Set the Probe Attenuation Coefficient" in Page 13). If the probe attenuation coefficient is 1:1, the

input channel ratio of the channel shall also be set to 1X, so as to avoid errors in the displayed gear factors and measured data.

Taking **Channel 1** as an example, if the probe attenuation coefficient is **10:1**, the operating steps are as follows:

- (1) Click **CH1** Information Box to call **CH1 Setting** menu.
- (2) Click **Display** switch in the Menu to highlight it.
- (3) In the menu, select **10X** in the **Probe Attenu** option.

#### 4. Set channel label

Taking **Channel 1** as an example, the operating steps are as follows:

- (1) Click **CH1** Information Box to call **CH1 Setting** menu.
- (2) Click **Display** switch in the Menu to highlight it.
- (3) In the menu, click **Label** switch to highlight it. According to the requirement by selecting **Common** or **Custom** mode to set the channel label.

#### 5. Set amplitude unit

Taking **Channel 1** as an example, the operating steps are as follows:

- (1) Click **CH1** Information Box to call **CH1 Setting** menu.
- (2) Click **Display** switch in the Menu to highlight it.
- (3) Click **Unit** menu, the optional units are V、A、W and U. Default unit is V.

#### 6. Set bandwidth limit

Taking **Channel 1** as an example, the operating steps are as follows:

- (1) Click CH1 Information Box to call **CH1 Setting** Menu.
- (2) Click **Display** switch in the menu to highlight it.
- (3) Click **Full Bandwidth** in the **Limit** menu. The high-frequency components contained in the measured signal can be passed through.
- (4) Click **20MHz** in the **Limit** menu. The bandwidth is limited to 20MHz and the high-frequency components larger than 20MHz contained in the measured signal will be blocked.

#### 7. Set voltage gear

Taking **Channel 1** as an example, the operating steps are as follows:

- (1) Click CH1 Information Box to call **CH1 Setting** Menu.
- (2) Click **Display** switch in the menu to highlight it.
- (3) Click the numeric box in the **Scale** Menu to display the gear select box. It is available to swipe the screen up and down with the finger to select the required gear value.

#### 8. Set vertical position

Take **Channel 1** as an example, the operating steps are as follows:

- (1) Click **CH1** Information Box to call **CH1 Setting** Menu.

- (2) Click **Display** switch in the menu to highlight it.
- (3) Click the numeric value in the **Offset** Menu to display the setup box of vertical position; it is available to directly input the value or turn the general knob to set the required vertical position.

### Application of Vertical Displacement Knob and Vertical Gear Knob

1. **Vertical Displacement** knob to adjust the vertical displacement of corresponding channel waveform.  
The resolution of this control key changes with the vertical gear.
2. **Vertical Gear** knob to adjust the vertical resolution of corresponding channel waveform.  
Determine the sensitivity of the vertical gear by stepping in a 1-2-5 system mode.

The vertical displacement and vertical channel information are shown in the lower left of the screen, as shown in Figure 5-4.



Figure 5-4: Vertical Information

## How to set horizontal system

There are **HOR** key, **Horizontal Displacement** knob and **Horizontal Gear** knob in the Horizontal System Control Area.

1. **Horizontal Displacement** knob: Adjust the horizontal displacement of all channels (including the mathematical operation), whose resolution changes with the time base.
2. **Horizontal Gear** knob: Set the horizontal scale factor for the main window or amplified window.
3. **HOR** key: Open the horizontal setting box, which can be switched between the normal mode and the waveform amplification mode. See

the following part for specific introduction to the waveform amplification.

The descriptions of **horizontal system** menu are shown in the table below:

Menu	Settings	Instruction
Zoom Mode		Click to display/close zoom mode.
Navigate		Through the navigation function, observe the situation of moving waveform. Note: The navigation function is used only when the running status is STOP(Acquire stop).
Expand	Center	Horizontal expansion refers to the reference position on which the screen waveform is horizontally expanded or compressed when the horizontal time base is adjusted. This instrument supports horizontal extension data including centers and trigger points default to "centers". Center: When changing the horizontal time base, the waveform expands or compresses horizontally around the center of the screen.
	Trigger	Trigger: When the horizontal time base is changed, the waveform expands or compresses horizontally around the trigger point.
Time Base		Set the horizontal time base gear of window.
Horizontal		Set the horizontal position of windows .

### Waveform Amplification

Click the panel horizontal control area **HOR** button or click the **Horizontal Information Box** at the lower part of the screen, display Horizontal Setting Box, click **Amplification Mode** switch to highlight it and enter the waveform amplification mode; the main window is displayed at the top half of the screen and the amplified window is displayed at the bottom half of the screen. The amplified window is the amplified part of the main window that is selected.





In normal mode, the **Horizontal Displacement** knob and the **Horizontal Gear** knob are used to adjust the horizontal position and the horizontal time base of the main window.



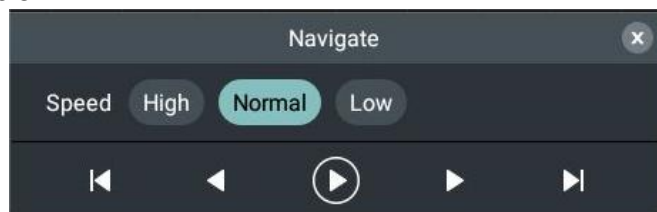

In waveform amplification mode, the **Horizontal Displacement** knob and the **Horizontal Gear** knob are used to adjust the horizontal position and the horizontal time base of the amplified window.

### Navigate function



Press the front of horizontal system control area **HOR** button or click the bottom of screen **Horizontal Information Box**, display Horizontal Setting Box and click **Navigate** to enter navigate menu. Click the menu  or 

can start/stop playback. During play click  button can play directly to the

far left, click  button can play directly to the far right. Click the previous button during playback  (Play left) or the next button  (Play right) can change play direction, and it stops playing when it reaches the leftmost or rightmost end. When play stops, click the previous button  or the next button  also can shift waveform. Click **Speed** can select waveform play



speed High、 Normal and Low mode.Click  can close the navigation menu.

**Note:**

For the operations related to the touch screen, refer to “How to use touch screen control ” in page 20.

## How to set trigger

Trigger determines when the oscilloscope starts to collect the data and display the waveform. Once it is set properly, it can convert unstable display into the meaningful waveform.

When the oscilloscope starts to collect the data, enough data are used to draw the waveform at the left of the trigger point. The oscilloscope continuously collects data while waiting for the trigger conditions. When a trigger is detected, the oscilloscope will continuously collect enough data to draw the waveform at the right of the trigger point.

There is one knob and two function menu keys in the Trigger Control Area.

**Trigger Level:** Turn this knob to set the signal voltage of corresponding trigger point and press this knob to make the trigger level at the vertical midpoint of the trigger signal amplitude.

**Forced Trigger:** Generate a trigger signal forcibly, mainly used in the “Normal” and “Single” trigger mode.

**Trigger Menu:** Trigger menu keys.

## Trigger Control

3 modes are available to enter the trigger control:

**Key Operation:** Press **Menu** in the trigger menu area to pop up the trigger menu setting box on the screen, then directly click **Type** to select the trigger mode.

**Main Menu Operation:** Click the main menu key  in the lower right of the screen to pop up the main menu interface, select **Trigger** Menu to pop up the trigger menu setting box in the middle of the screen, and then directly click **Type** to select the trigger mode.

**Trigger Information Box Operation:** Click **Edge** Shortcut Window at the lower part of the screen to pop up the trigger menu setting box on the screen, then directly click **Type** to select the trigger mode.

Trigger Mode:

There are 14 trigger modes, including **Edge Trigger, Video Trigger, Pulse Width Trigger, Slope Trigger, Runt Trigger, Over-amplitude Trigger, Timeout Trigger, Nth Edge Trigger, Logic Trigger, RS232 Trigger, IC2 Trigger, SPI Trigger, CAN Trigger and LIN Trigger.**

These 14 trigger modes are illustrated as follows.





### 1. Edge Trigger

Trigger on the trigger level of the input signal edge. When the “Edge Trigger” is selected, it is triggered on the rising edge and falling edge of the input signal. Enter the edge trigger and the trigger setting information is displayed at the

lower part of the screen, such as , indicating that the edge trigger is selected with the trigger signal source of CH1, trigger coupling of DC, slope of falling edge and trigger level of 1.000V.

The descriptions of **edge trigger** menu are shown in the table below:

Menu	Settings	Instruction
Type	Edge	Set the trigger type of the vertical channel to edge trigger.
Source	CH1	Set Channel 1 as the signal source trigger signal.
	CH2	Set Channel 2 as the signal source trigger signal.
	EXT	Set the external trigger input channel as the signal source trigger signal.
	EXT/5	Set the external trigger source divided by 5 to extend the external trigger level range.

	AC Lines	Set the mains supply as the trigger signal source.
Coupling	DC	Set to block the DC components from passing through.
	AC	Set to allow all components to pass through.
	HF	Block the high-frequency signal from passing through and only allow low-frequency signal to pass through.
Slope		Set to trigger at the rising edge of the signal.
		Set to trigger at the falling edge of the signal.
Level		Indicate the vertical trigger position of the channel, turn trigger level knob or slide your finger up and down to change the trigger level on the right side of the waveform display area of the screen, ; upon setting, a gray solid line will appear indicating the trigger level position and the trigger level value in the trigger information display box at the bottom edge of the screen will change accordingly. After the setting is completed, the solid line will disappear. Click 50% and set the shortcut key of trigger level in the vertical midpoint of the trigger signal amplitude.
	50%	
Mode	Auto	Set to collect waveform even when no trigger condition is detected.
	Normal	Set to collect waveform only when trigger conditions are satisfied.
	Single	Set to acquire a waveform when one trigger is detected and then stop acquisition.
HoldOff		100ns – 10s; click <b>Numeric Input Box</b> to input the interval to be set for restarting the trigger circuit and click the unit to confirm; or click Gear Input Box (- or +) or turn the <b>General</b> knob to set the interval for restarting the trigger circuit, and click < > or press  or  to move the cursor and select the digit to be set.
	100ns	Set the trigger hold-off time as 100ns.
Sensitivity		Set the sensitivity of the trigger window.



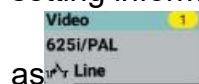

## 2. Video Trigger

Select the **Video Trigger** to trigger on standard video signal field or line of **525i/NTSC**, **625i/PAL** or **SECAM**. Enter the video trigger and the trigger setting information is displayed in the lower part of the screen, such



as  Line, indicating that the video trigger is selected with the trigger information source of CH1 and synchronization type of line.

The descriptions of **video trigger** menu are shown in the table below:

Menu	Setting	Descriptions
Type	Video	Set the trigger type of the vertical channel to video trigger.
Source	CH1 CH2	Set Channel 1 as the signal source trigger signal. Set Channel 2 as the signal source trigger signal.
Standard	525i/NTSC 625i/PAL SECAM	Set the system standard of the video.
Sync	Line Field Odd Even Line NO.	Set to trigger the synchronization on the video line. Set to trigger the synchronization on the video field. Set to trigger the synchronization on the video odd field. Set to trigger the synchronization on the video even field. Set to trigger the synchronization on the specified video line; click <b>Numeric Input Box</b> to input the number of specified line to be set and click <b>OK</b> to confirm; or click <b>Gear Input Box (- or +)</b> or turn the <b>General knob</b> to set the number of specified line, and click < > or press  or  to move the cursor and select the digit to be set.
Mode	Auto Normal Single	Set to collect waveform even when no trigger condition is detected. Set to collect waveform only when trigger conditions are satisfied. Set to acquire a waveform when one trigger is detected and then stop acquisition.
HoldOff	100ns	100ns – 10s; click <b>Numeric Input Box</b> to input the interval to be set for restarting the trigger circuit and click the unit to confirm; or click <b>Gear Input Box (- or +)</b> or turn the <b>General knob</b> to set the interval for restarting the trigger circuit, and click < > or press  or  to move the cursor and select the digit to be set. Set the trigger hold-off time as 100ns.



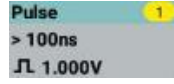

### 3. Pulse Width Trigger

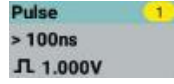

Pulse width trigger is to determine the trigger moment based on the pulse width. You can discover abnormal pulse by setting the pulse width conditions. Enter the pulse width trigger and the trigger setting information is displayed in



the lower part of the screen, such as , indicating that the pulse width trigger is selected with the trigger signal source of CH1, polarity of positive pulse width and trigger level value of 1.000V.

The descriptions of **pulse width trigger** menu are shown in the table below:

Menu	Setting	Descriptions
Type	Pulse	Set the trigger type of the vertical channel to pulse width trigger.
Source	CH1 CH2	Set Channel 1 as the signal source trigger signal. Set Channel 2 as the signal source trigger signal.
Polarity		Select the polarity.
Time	> = < Time setting	Click  to set the pulse condition, click time setting's <b>Numeric Input Box</b> to input the pulse width time to be set and click the unit to confirm; or click Gear Input Box (- or +) or turn the <b>General</b> knob to set the pulse width time, and click < > or press  or  to move the cursor and select the digit to be set.
Threshold	50%	Click Numeric Display Box and turn <b>General</b> knob to set the lower threshold; Click <b>50%</b> and set the shortcut key of trigger level in the vertical midpoint of the trigger signal amplitude.
Mode	Auto Normal Single	Set to collect waveform even when no trigger condition is detected. Set to collect waveform only when trigger conditions are satisfied. Set to acquire a waveform when one trigger is detected and then stop acquisition.

HoldOff	100ns	100ns – 10s; click <b>Numeric Input Box</b> to input the interval to be set for restarting the trigger circuit and click the unit to confirm; or click Gear Input Box (- or +) or turn the <b>General</b> knob to set the interval for restarting the trigger circuit, and click < > or press  or  to move the cursor and select the digit to be set. Set the trigger hold-off time as 100ns.
Sensitivity		Set the sensitivity of the trigger window.





### 4. Slope Trigger

Slope Trigger is to set the oscilloscope to trigger with the positive or negative slope at a specified time. Enter the slope trigger and the trigger setting



information is displayed in the lower part of the screen, such as ,

indicating that the slope trigger is selected with the trigger signal source of CH1, trigger condition of rising slope and 0.00uV of the difference between the upper threshold and the lower threshold.

The descriptions of **Slope Trigger** menu are shown in the table below:

Menu	Setting	Descriptions
Type	Slope	Set the trigger type of the vertical channel to slope trigger.
Source	CH1 CH2	Set Channel 1 as the signal source trigger signal. Set Channel 2 as the signal source trigger signal.
Slope	 	Select the slope conditions.
Time	> = < Time setting	Click  to set the slope conditions, click time setting's <b>Numeric Input Box</b> to input the slope time to be set and click the unit to confirm; or click Gear Input Box (- or +) or turn <b>General</b> knob to set the slope time, and click < > or press  or  to move the cursor and select the digit to be set.
Upper Threshold	50%	Click Numeric Display Box and turn <b>General</b> knob to set the upper threshold; Click <b>50%</b> and set the shortcut key of trigger level in the vertical midpoint of the trigger signal amplitude.

## 5. Use the Oscilloscope

Lower Threshold	50%	Click Numeric Display Box and turn <b>General</b> knob to set the lower threshold; Click <b>50%</b> and set the shortcut key of trigger level in the vertical midpoint of the trigger signal amplitude.
Slew Rate		$\text{Slope} = (\text{Upper Threshold} - \text{Lower Threshold}) / \text{Slope Trigger Time}$
Mode	Auto Normal Single	Set to collect waveform even when no trigger condition is detected. Set to collect waveform only when trigger conditions are satisfied. Set to acquire a waveform when one trigger is detected and then stop acquisition.
HoldOff	100ns	100ns – 10s; click <b>Numeric Input Box</b> to input the interval to be set for restarting the trigger circuit and click the unit to confirm; or click Gear Input Box (- or +) or turn the <b>General</b> knob to set the interval for restarting the trigger circuit, and click < > or press  or  to move the cursor and select the digit to be set. Set the trigger hold-off time as 100ns.
Sensitivity		Set the sensitivity of the trigger window.



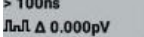

## 5. Runt Trigger

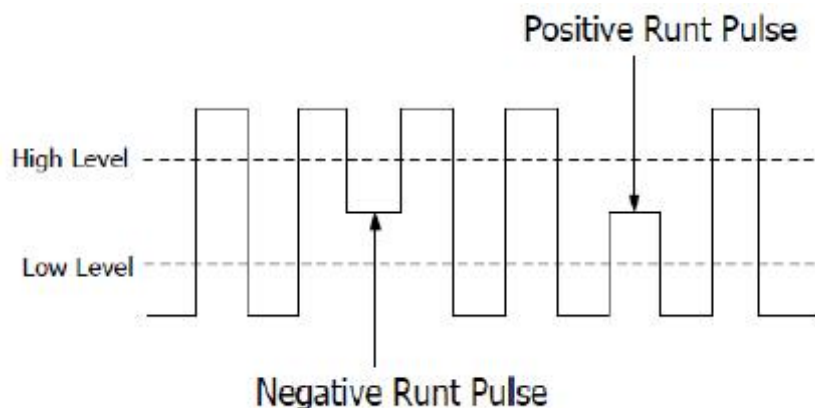
Used to trigger a pulse that steps over one trigger level but not another. Enter the runt trigger and the trigger setting information is displayed at the



lower part of the screen, such as , indicating that the runt trigger is selected with the trigger signal source of CH1, the polarity of positive runt and 0.000pV of the difference between upper level and lower level, as shown in the figure,



The descriptions of  **runt trigger**  menu are shown in the table below:

Menu	Setting	Descriptions
Type	Runt	Set the trigger type of the vertical channel to under-amplitude trigger.
Source	CH1 CH2	Set Channel 1 as the signal source trigger signal. Set Channel 2 as the signal source trigger signal.
Polarity	 	Positive polarity, trigger on the positive under-amplitude pulse. Negative polarity, trigger on the negative under-amplitude pulse.
Time	Time setting  > = <	Click  to set the pulse width conditions, click time setting's <b>Numeric Input Box</b> to input the pulse width to be set and click the unit to confirm; or click Gear Input Box (- or +) or turn <b>General</b> knob to set the pulse width, and click < > or press  or  to move the cursor and select the digit to be set. Trigger when runt pulse is greater than the set pulse width. Trigger when runt pulse equals to the set pulse width. Trigger when runt pulse is lower than the set pulse width.
Upper Threshold	50%	Click Numeric Display Box and turn <b>General</b> knob to set the upper threshold; Click <b>50%</b> and set the shortcut key of trigger level in the vertical midpoint of the trigger signal amplitude.
Lower Threshold	50%	Click Numeric Display Box and turn <b>General</b> knob to set the lower threshold; Click <b>50%</b> and set the shortcut key of trigger level in the vertical midpoint of the trigger signal amplitude.
Mode	Auto Normal Single	Set to collect waveform even when no trigger condition is detected. Set to collect waveform only when trigger conditions are satisfied. Set to acquire a waveform when one trigger is detected and then stop acquisition.



HoldOff	100ns	100ns – 10s; click <b>Numeric Input Box</b> to input the interval to be set for restarting the trigger circuit and click the unit to confirm; or click Gear Input Box (- or +) or turn the <b>General</b> knob to set the interval for restarting the trigger circuit, and click < > or press  or  to move the cursor and select the digit to be set. Set the trigger hold-off time as 100ns.
Sensitivity		Set the sensitivity of the trigger window.









## 6. Windows Trigger



Provide a high trigger level and low trigger level, the oscilloscope triggers when the input signal passes through the high trigger level or the low trigger level.

In Windows Trigger mode, the trigger setting information is displayed on

bottom right of the screen, for example, , indicates that trigger type is windows, trigger source is CH1, polarity is positive, 0.000pV the differential between up level and low level threshold.

The descriptions of **windows trigger** menu are shown in the table below:

Menu	Setting	Descriptions
Type	Windows	Set vertical channel trigger type as Windows trigger.
Source	CH1 CH2	Set Channel 1 as the signal source trigger signal. Set Channel 2 as the signal source trigger signal.
Polarity	 	Positive over-amplitude pulse . Negative over-amplitude pulse.
Conditions	     	Enter: Triggers when the trigger signal enters the specified trigger level range. Exit: Triggers when the trigger signal exits the specified trigger level range. Time: Specify the hold time of the input signal after entering the specified trigger level. The oscilloscope triggers when the accumulated hold time is greater than the windows time. Available range is 30ns-10s, default 100ns.
Upper Threshold	50%	Click Numeric Display Box and turn <b>General</b> knob to set the upper threshold; Click <b>50%</b> and set the shortcut key of trigger level in the vertical midpoint of the trigger signal amplitude.



Lower Threshold	50%	Click Numeric Display Box and turn <b>General</b> knob to set the lower threshold; Click <b>50%</b> and set the shortcut key of trigger level in the vertical midpoint of the trigger signal amplitude.
Mode	Auto Normal Single	Set to collect waveform even when no trigger condition is detected. Set to collect waveform only when trigger conditions are satisfied. Set to acquire a waveform when one trigger is detected and then stop acquisition.
HoldOff	100ns	100ns – 10s; click <b>Numeric Input Box</b> to input the interval to be set for restarting the trigger circuit and click the unit to confirm; or click Gear Input Box (- or +) or turn the <b>General</b> knob to set the interval for restarting the trigger circuit, and click < > or press  or  to move the cursor and select the digit to be set. Set the trigger hold-off time as 100ns.
Sensitivity		Set the sensitivity of the trigger window.

## 7. Timeout Trigger



Trigger when the interval from the time at which the rising (or falling) edge of the input signal passes through the touch level to the time when the adjacent falling (or rising) edge passes through the touch level is larger than the set timeout period. Enter the timeout trigger and the trigger setting information is

displayed at the lower part of the screen, such as , indicating that the timeout trigger type is selected with 1.000V of the trigger level value.

The descriptions of **timeout trigger** menu are shown in the table below:

Menu	Setting	Descriptions
Type	Timeout	Set the trigger type of the vertical channel as timeout trigger.
Source	CH1 CH2	Set Channel 1 as the signal source trigger signal. Set Channel 2 as the signal source trigger signal.
Slope	 	Set to start timing when the rising edge of the input signal passes through the trigger level. Set to start timing when the falling edge of the input signal passes through the trigger level.

## 5. Use the Oscilloscope

Idle Time		Set the idle time. It refers to the minimum time that the clock signal must be in idle state before the oscilloscope begins to search for data that meets the trigger conditions. The idle time ranges from 30ns to 10s with default value of 100ns.
Threshold	50%	Click Numeric Display Box and turn <b>General</b> knob to set the lower threshold; Click <b>50%</b> and set the shortcut key of trigger level in the vertical midpoint of the trigger signal amplitude.
Mode	Auto Normal Single	Set to collect waveform even when no trigger condition is detected. Set to collect waveform only when trigger conditions are satisfied. Set to acquire a waveform when one trigger is detected and then stop acquisition.
HoldOff	100ns	100ns – 10s; click <b>Numeric Input Box</b> to input the interval to be set for restarting the trigger circuit and click the unit to confirm; or click Gear Input Box (- or +) or turn the <b>General</b> knob to set the interval for restarting the trigger circuit, and click < > or press  or  to move the cursor and select the digit to be set. Set the trigger hold-off time as 100ns.
Sensitivity		Set the sensitivity of the trigger window.

## 8. Nth Edge trigger





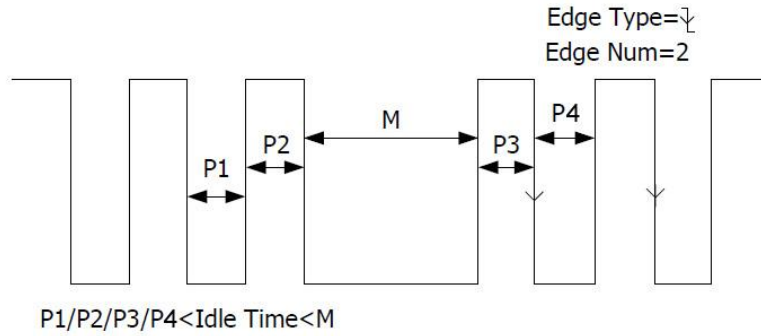

The oscilloscope triggers on the Nth edge that appears on the specified idle time. As figure shown below, the oscilloscope should trigger on the second falling edge after the specified idle time and the idle time should be set to  $P1/P2/P3/P4 < \text{Idle Time} < M$ . Wherein, M, P1, P2, P3 and P4 are positive or negative pulse width participating in the counting.



In Nth Edge Trigger mode, the trigger setting information is displayed on

bottom right of the screen, for example,  , indicates that trigger type is Nth Edge, trigger source is CH1, 1.000V is up level or low level threshold.



The descriptions of the **Nth edge trigger** menu are shown in the table below:

Menu	Setting	Descriptions
Type	Nth Edge	Set vertical channel trigger type as Nth Edge trigger.
Source	CH1 CH2	Set Channel 1 as the signal source trigger signal. Set Channel 2 as the signal source trigger signal.
Slope	 	Trigger on the rising edge of the input signal when voltage level meets the specified trigger level. Trigger on the falling edge of the input signal when voltage level meets the specified trigger level.
Idle Time		Set the time before starting the edge counting in the Nth edge trigger. Click <b>Numeric Input Box</b> to input the idle time to be set for restarting the trigger circuit and click the unit to confirm; or click Gear Input Box (- or +) or turn the <b>General</b> knob to set the idle time for restarting the trigger circuit, and click < > or press  or  to move the cursor and select the digit to be set. The time that can be set ranges from 30ns to 10s with default value of 100ns
Edge Num		Set the specific value of N in the Nth edge trigger. Click <b>Numeric Input Box</b> to input the edge number to be set and click <b>OK</b> to confirm; or click Gear Input Box (- or +) or turn the <b>General</b> knob to set the edge number, and click < > or press  or  to move the cursor and select the digit to be set.

Threshold	50%	Click Numeric Display Box and turn <b>General</b> knob to set the required threshold; Click <b>50%</b> and set the shortcut key of trigger level in the vertical midpoint of the trigger signal amplitude.
Mode	Auto Normal Single	Set to collect waveform even when no trigger condition is detected. Set to collect waveform only when trigger conditions are satisfied. Set to acquire a waveform when one trigger is detected and then stop acquisition.
HoldOff	100ns	100ms – 10s; click <b>Numeric Input Box</b> to input the interval to be set for restarting the trigger circuit and click the unit to confirm; or click Gear Input Box (- or +) or turn the <b>General</b> knob to set the interval for restarting the trigger circuit, and click < > or press  or  to move the cursor and select the digit to be set. Set the trigger hold-off time as 100ns.
Sensitivity		Set the sensitivity of the trigger window.

## 9. Logic Trigger





Determine the trigger conditions with the logical relations.

Enter the logic trigger and the trigger setting information is displayed at the

lower part of the screen, such as , indicating that the logic trigger type is selected with the logic mode of AND, input mode of high level and output mode of Turn True.



**Note: When a rising or falling edge is set for one channel, it can not do the same for another.**

The descriptions of the **Logic trigger** menu are shown in the table below:

Menu	Setting	Descriptions
Type	Logic	Set vertical channel trigger type as Logic trigger.
Logic Mode	AND  OR  XOR  XNOR 	Set logic mode as AND. Set logic mode as OR. Set logic mode as XOR. Set logic mode as XNOR.

5. Use the Oscilloscope

CH1 Input Mode	High Low High/Low Rise Fall	Set CH1 as High Level, Low level, high or low level, Rise and Fall.
CH2 Input Mode	High Low High/Low Rise Fall	Set CH2 as High Level, Low level, high or low level, Rise and Fall.
Output Mode	GoesTrue GoesFalse True> True= True<	Click  to select the output mode. GoseTrue: Trigger when condition turns True from False. GoseFalse: Trigger when condition turns False from True. Ture >: Trigger when the time of true condition is more than the set time. Ture =: Trigger when the time of true condition is equal to the set time. Ture <: Trigger when the time of true condition is lower than the set time.
CH1 Threshold	50%	Click Numeric Display Box and turn <b>General</b> knob to set the CH1 Threshold; Click <b>50%</b> and set the shortcut key of trigger level in the vertical midpoint of the trigger signal amplitude.
CH2 Threshold	50%	Click Numeric Display Box and turn <b>General</b> knob to set the CH2 Threshold; Click <b>50%</b> and set the shortcut key of trigger level in the vertical midpoint of the trigger signal amplitude.
Mode	Auto Normal Single	Set to collect waveform even when no trigger condition is detected. Set to collect waveform only when trigger conditions are satisfied. Set to acquire a waveform when one trigger is detected and then stop acquisition.

HoldOff	100ns	100ns – 10s; click <b>Numeric Input Box</b> to input the interval to be set for restarting the trigger circuit and click the unit to confirm; or click Gear Input Box (- or +) or turn the <b>General</b> knob to set the interval for restarting the trigger circuit, and click < > or press  or  to move the cursor and select the digit to be set. Set the trigger hold-off time as 100ns.
Sensitivity		Set the sensitivity of the trigger window.

## 10. RS232 Trigger



RS232 bus is a serial data communication mode used for data transmission between computers or between the computer and the terminal. RS232 serial protocol transmit a character as a frame of data, the frame structure is composed of 1 start bit, 5-8 data bits, 1 check bit and 1-2 stop bit(s), with the format as shown in the figure below. It is triggered when a start frame, error frame, check error or specified data is detected.

Enter the RS232 bus trigger and the trigger setting information is displayed at





the lower part of the screen, such as , indicating that the RS232 trigger mode is selected with the trigger signal source of CH1, CH1 baud rate of 9,600bps and CH1 trigger level of 1.000V.



The descriptions of **RS232 trigger** menu are shown in the table below:

Menu	Setting	Descriptions
Type	RS232	Set the buss trigger type to RS232 trigger.
Source	CH1 CH2	Set Channel 1 as the signal source trigger signal. Set Channel 2 as the signal source trigger signal.
Polarity	 	Select positive polarity for data transmission. Select reverse polarity for data transmission.
Baud	Common Custom	Click Numeric Display Box and turn General knob to set the commonly-used baud rate. Click Numeric Display Box to input the baud rate to be set and click unit to confirm; or click Gear

5. Use the Oscilloscope

		Input Box (- or +) or turn the <b>General</b> knob to set the baud rate, and click < > or press  or  to move the cursor and select the digit to be set. The baud rate ranges from 50 to 10,000,000.
Threshold	50%	Click Numeric Display Box and turn <b>General</b> knob to set the required threshold; Click <b>50%</b> and set the shortcut key of trigger level in the vertical midpoint of the trigger signal amplitude.
Condition	Start	Trigger at the frame starting position.
	Error	Trigger when an error frame is detected, and set after selecting this trigger condition: <b>Stop Bit:</b> Select "1 bit" or "2 bits". <b>Parity Check:</b> "N/A" refers to no check; "Even" refers to even check and "Odd" refers to odd check; the oscilloscope determines if there is any check error based on this setting.
	Chk Error	Trigger when a check error is detected. After selecting this trigger conditions, click <b>Parity Check</b> to select even check or odd check.
	Data	Trigger at the last bit of the set data bit and set after selecting this trigger condition: <b>Data Bit Width:</b> Set to 5, 6, 7, or 8 bits. Data: Based on the set data bit width, the data range is (between 0 and 2 data bits width power -1)
Mode	Auto	Set to collect waveform even when no trigger condition is detected.
	Normal	Set to collect waveform only when trigger conditions are satisfied.
	Single	Set to acquire a waveform when one trigger is detected and then stop acquisition.
HoldOff		100ns – 10s; click <b>Numeric Input Box</b> to input the interval to be set for restarting the trigger circuit and click the unit to confirm; or click Gear Input Box (- or +) or turn the <b>General</b> knob to set the interval for restarting the trigger circuit, and click < > or press  or  to move the cursor and select the digit to be set.
	100ns	Set the trigger hold-off time as 100ns.
Sensitivity		Set the sensitivity of the trigger window.



## 11. I2C Trigger

I2C serial bus consists of two lines, SCL and SDA, with the transmission rate determined by the clock line SCL and transmission data by SDA, as shown in the figure, it can be triggered upon start, restart, stop, loss confirmation and specific equipment address or data value.

Enter the I2C bus trigger and the trigger setting information is displayed at

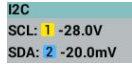

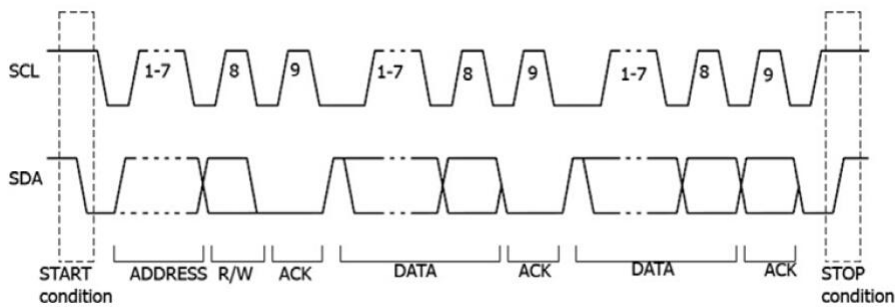
the lower part of the screen, such as , indicating that the I2C trigger type is selected with CH1 SCL trigger level of -28.0V and CH2 SDA trigger level of -20.0mV.



The descriptions of the **I2C trigger** menu are as follows:

Menu	Setting	Descriptions
Type	I2C	Set the bus trigger type to I2C.
SCL	CH1 CH2	Set Channel 1 as SCL. Set Channel 2 as SCL.
Threshold	50%	Click Numeric Display Box and turn <b>General</b> knob to set the SCL threshold; Click 50% and set the shortcut key of trigger level in the vertical midpoint of the trigger signal amplitude.
SDA	CH1 CH2	Set Channel 1 as SDA. Set Channel 2 as SDA.
Threshold	50%	Click Numeric Display Box and turn <b>General</b> knob to set the SDA threshold; Click 50% and set the shortcut key of trigger level in the vertical midpoint of the trigger signal amplitude.
Condition	Start	Trigger when SCL is in high level and SDA is from high level to low level.
	Restart	Trigger when another starting condition occurs before the stopping condition.
	Stop	Trigger when SCL is in high level and SDA

5. Use the Oscilloscope

		is from low level to high level.
	Ack Lost	Trigger when SDA data is in high level during any SCL clock bit period.
	Addr	<p>Addr Bits Set the address bit width to “7-bit”, “8-bit” or “10-bit”.</p> <p>Addr The address ranges from 0 to 127, from 0 to 255 and from 0 to 1023 depending on the address bit width.</p> <p>Direction Set the data direction to read or write. Note: This setting is not available when the address bit width is 8.</p>
	Data	<p>Byte Length Search for the set data value on the data line and trigger on the edge of the last clock line in the data. Set the byte length of the data ranging from 1 byte to 5 bytes. Turn <b>General</b> knob to set it.</p> <p>Data Set the data code type on current data bit.</p>
	Addr /Data	Search for the set address value and data value simultaneously and trigger when both meet the trigger conditions; for specific settings, refer to the setting of address format and data format.
Mode	<p>Auto Set to collect waveform even when no trigger condition is detected.</p> <p>Normal Set to collect waveform only when trigger conditions are satisfied.</p> <p>Single Set to acquire a waveform when one trigger is detected and then stop acquisition.</p>	
HoldOff	100ns	<p>100ns – 10s; click <b>Numeric Input Box</b> to input the interval to be set for restarting the trigger circuit and click the unit to confirm; or click Gear Input Box (- or +) or turn the <b>General</b> knob to set the interval for restarting the trigger circuit, and click &lt; &gt; or press  or  to move the cursor and select the digit to be set.</p> <p>Set the trigger hold-off time as 100ns.</p>
Sensitivity		Set the sensitivity of the trigger window.





## 12. SPI Trigger

Trigger when the timeout conditions are met and the specified data is found by the oscilloscope. In SPI trigger mode, it is required to specify SCL (Serial Clock Line) and SDA (Serial Clock Data).





Enter the SPI bus trigger and the trigger setting information is displayed at the

lower part of the screen, such as , indicating that the SPI trigger mode is selected with the CH1 SCL trigger level of -28.0V and CH2 SDA trigger level of -20.0mV.

The descriptions of **SPI Trigger** Menu are as follows:

Menu	Setting	Descriptions
Type	SPI	Set the trigger type of the vertical channel to SIP trigger.
SCL	CH1 CH2	Set Channel 1 as the SCL mode. Set Channel 2 as the SCL mode.
Threshold	50%	Click Numeric Display Box and turn <b>General</b> knob to set the SCL threshold; Click 50% and set the shortcut key of trigger level in the vertical midpoint of the trigger signal amplitude.
SDA	CH1 CH2	Set Channel 1 as the SDA mode. Set Channel 2 as the SDA mode.
Threshold	50%	Click Numeric Display Box and turn <b>General</b> knob to set the SDA threshold; Click 50% and set the shortcut key of trigger level in the vertical midpoint of the trigger signal amplitude.
Timeout		Set the minimum idle period that is, one SCL cycle ranging from 30ns to 10s with default value of 100ns. Timeout occurs when the SDA meeting the trigger conditions is found by the oscilloscope after the SCL signal remains idle for a specified time; Click Numeric Input Box to input the timeout period to be set and click the unit to confirm; or click Gear Input Box (- or +) or turn <b>General</b> knob to set the timeout period, click < > or press   to move the cursor and select the digit to be set. For idle state value, press   or click

## 5. Use the Oscilloscope

		 to move the cursor and select the digit to be set.
Clock Edge	 	Set the clock edge to rising edge or falling edge. The rising edge refers to acquire the SDA at the rising edge of the clock; the falling edge refers to acquire the SDA at the falling edge of the clock.
Data Bits		Set the number of bits in the serial data string ranging from 4 to 32 bits; click Numeric Display Box and turn <b>General Knob</b> to set the data bit width.
Data		Set the data bit.
Mode	Auto Normal Single	Set to collect waveform even when no trigger condition is detected. Set to collect waveform only when trigger conditions are satisfied. Set to acquire a waveform when one trigger is detected and then stop acquisition.
HoldOff	100ns	100ns – 10s; click <b>Numeric Input Box</b> to input the interval to be set for restarting the trigger circuit and click the unit to confirm; or click Gear Input Box (- or +) or turn the <b>General</b> knob to set the interval for restarting the trigger circuit, and click < > or press  or  to move the cursor and select the digit to be set. Set the trigger hold-off time as 100ns.
Sensitivity		Set the sensitivity of the trigger window.

## 13. CAN Trigger

CAN, the abbreviation of Controller Area Network, is the serial communication protocol of ISO international standardization.





In CAN bus trigger mode, it can be triggered upon **Start of Frame, Frame Type, ID, Data, ID/Data, End of Frame, Loss Confirmation** or **Padding Error**. It is required to specify the signal source, signal type, acquisition point and signal rate.

Enter the CAN bus trigger and the trigger setting information is displayed



at the lower right of the screen, such as , indicating that the CAN trigger type is selected with the trigger signal source of CH1, frame type of CAN\_H and the baud rate of 1,000,000bps.

## 5. Use the Oscilloscope

The descriptions of CAN trigger menu are as follows:

Menu	Setting	Descriptions		
Type	CAN	Set the bus trigger type as CAN.		
Source	CH1 CH2	Set Channel 1 as the signal source trigger signal. Set Channel 2 as the signal source trigger signal.		
Type	CAN_H CAN_L TX RX	Actual CAN_H bus signal. Actual CAN_L bus signal. Sending signal from CAN signal line. Receiving signal from CAN signal line.		
Sample Point		Click <b>Numeric Input Box</b> to input the point within the bit time to be set and click % to confirm; or click Gear Input Box (- or +) or turn <b>General</b> knob to set the point within the bit time, click < > or press   to move the cursor and select the digit to be set. The oscilloscope start acquisition to bit level at this point. The position of acquisition point is indicated with the percentage of "bit start to acquisition point" to "bit time", ranging from 5% to 95%.		
Baud	Common	Click Numeric Display Box and turn General knob to select the baud rate from the table.		
	Custom	Click <b>Numeric Display Box</b> to input the baud rate to be set and click the unit to confirm; or click Gear Input Box (- or +) or turn the <b>General</b> knob to set the baud rate, and click < > or press  or  to move the cursor and select the digit to be set. Set the baud rate ranging from 10,000 to 1,000,000.		
Threshold	50%	Click Numeric Display Box and turn <b>General</b> knob to set the required threshold; Click <b>50%</b> and set the shortcut key of trigger level in the vertical midpoint of the trigger signal amplitude.		
Condition	Start	Trigger at the frame start bit of the data frame.		
	Type	Type	Data	Trigger on the selected frame type.
			Remote	
			Error	
Overload				
ID	ID Format	Standard Extend	Select the ID format as standard or extended.	

5. Use the Oscilloscope

		ID Value		Use the General knob and arrow keys on the panel to set the ID value required.
	Data	Byte Length		Click Numeric Display Box and select the byte length required for the set data, ranging from 1 to 8.
		Data		Use the General knob and arrow keys on the panel to set the value required for the data.
	ID /Data	ID Format	Standard Extend	Select the ID format as standard or extended.
		ID Value		Use the General knob and arrow keys on the panel to set the ID value required.
		Byte Length		Click Numeric Display Box and select the byte length required for the set data, ranging from 1 to 8.
		Data		Use the General knob and arrow keys on the panel to set the value required for the data.
	End	Trigger at the frame end bit of the data frame.		
	Lost	Set the trigger condition to loss confirmation.		
	Error	Set the trigger condition to padding error.		
Mode	Auto	Set to collect waveform even when no trigger condition is detected.		
	Normal	Set to collect waveform only when trigger conditions are satisfied.		
	Single	Set to acquire a waveform when one trigger is detected and then stop acquisition.		
HoldOff		100ns – 10s; click <b>Numeric Input Box</b> to input the interval to be set for restarting the trigger circuit and click the unit to confirm; or click Gear Input Box (- or +) or turn the <b>General</b> knob to set the interval for restarting the trigger circuit, and click < > or press  or  to move the cursor and select the digit to be set.		
	100ns	Set the trigger hold-off time as 100ns.		
Sensitivity		Set the sensitivity of the trigger window.		

## 14. LIN Trigger

The LIN bus data frame format is shown in the figure below:

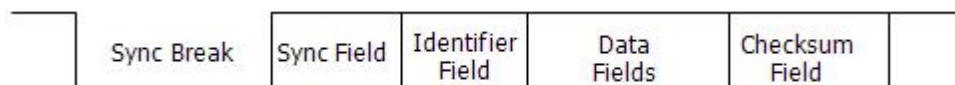



Trigger with LIN bus based on signal **Interval, frame type, ID/data** and **data error**. The signal source and signal rate specified by LIN is required.



Enter the LIN buss trigger and the trigger setting information is displayed at the

lower right of the screen, such as , indicating that the LIN trigger type is selected with the trigger signal source of CH1, baud rate of 1,000,000bps and trigger level of -28.0V.

The descriptions of **LIN trigger** menu are as follows:

Menu	Setting	Descriptions	
Type	LIN	Set the buss trigger type as LIN.	
Source	CH1 CH2	Set Channel 1 as the signal source trigger signal. Set Channel 2 as the signal source trigger signal.	
Baud	Common	Click Numeric Display Box and turn General knob to select the baud rate from the table.	
	Custom	Click <b>Numeric Display Box</b> to input the baud rate to be set and click the unit to confirm; or click Gear Input Box (- or +) or turn the <b>General</b> knob to set the baud rate, and click < > or press  or  to move the cursor and select the digit to be set. Set the baud rate ranging from 10,000 to 1,000,000.	
Threshold	50%	Click Numeric Display Box and turn <b>General</b> knob to set the required threshold; Click <b>50%</b> and set the shortcut key of trigger level in the vertical midpoint of the trigger signal amplitude.	
Condition	Break	Trigger at the frame start bit of the data frame.	
	ID	ID	Use General knob and arrow keys on the panel to set the ID valued required.
	ID /Data	ID	Use General knob and arrow keys on the panel to set the ID valued required.

## 5. Use the Oscilloscope

		Data	Use General knob and arrow keys on the panel to set the ID valued required.
	Data Error		Set the trigger condition to bit data error.
Mode	Auto		Set to collect waveform even when no trigger condition is detected.
	Normal		Set to collect waveform only when trigger conditions are satisfied.
	Single		Set to acquire a waveform when one trigger is detected and then stop acquisition.
HoldOff			100ns – 10s; click <b>Numeric Input Box</b> to input the interval to be set for restarting the trigger circuit and click the unit to confirm; or click Gear Input Box (- or +) or turn the <b>General</b> knob to set the interval for restarting the trigger circuit, and click < > or press  or  to move the cursor and select the digit to be set.
	100ns		Set the trigger hold-off time as 100ns.
Sensitivity			Set the sensitivity of the trigger window.

### How to operate function menu

In the function menu control area, there are 8 function menu keys, including **Measure, Acquire, Settings, Cursor, Math, Copy, Save** and **Display**, and 3 Execute Now keys, including **AutoSet, Run/Stop** and **Single**.

### How to conduct automatic measurement

Press **Measure** key or click Main Menu window and select **Measure** menu to conduct automatic measurement; there are 43 kinds of measurement including horizontal measurement, vertical measurement, Blend measurement and Inter-CH measurement, and a maximum of 8 measuring types can be displayed at the lower left of the screen.

**Horizontal Measurement includes:** Period, Frequency, + Width, - Width, Rise Time, Fall Time, Positive Duty Ratio, Negative Duty Ratio and Screen Pulse Width Ratio;

**Vertical Measurement includes:** Average Value, Peak-to-Peak Value, Root-mean-square Value, Maximum Value, Minimum Value, Top Value, Bottom Value, Amplitude, Pre-shoot, Over-shoot and Cycle Root-mean-square Value, Standard deviation;

**Mixed Measurement includes:** Number of Positive Pulse, Number of



Negative Pulse, Number of Rising Edge, Number of Falling Edge, Area and Cycle Area;

**Inter-channel Measurement includes:** Delayed (1  $\Psi$ -2  $\Psi$ ), Delayed (1  $\Psi$ -2  $\Psi$ ), Delayed (1  $\Psi$ -2  $\Psi$ ), Delayed (1  $\Psi$ -2  $\Psi$ ), Phase Position (1  $\Psi$ -2  $\Psi$ ), Phase Position (1  $\Psi$ -2  $\Psi$ ), Phase Position (1  $\Psi$ -2  $\Psi$ ), Phase Position (1  $\Psi$ -2  $\Psi$ ), FRR (1  $\Psi$ -2  $\Psi$ ), FRF (1  $\Psi$ -2  $\Psi$ ), FFR (1  $\Psi$ -2  $\Psi$ ), FFF (1  $\Psi$ -2  $\Psi$ ), LRR (1  $\Psi$ -2  $\Psi$ ), LRF (1  $\Psi$ -2  $\Psi$ ), LFR (1  $\Psi$ -2  $\Psi$ ), LFF (1  $\Psi$ -2  $\Psi$ ).

The descriptions of automatic measurement **function menu** are shown as follows:

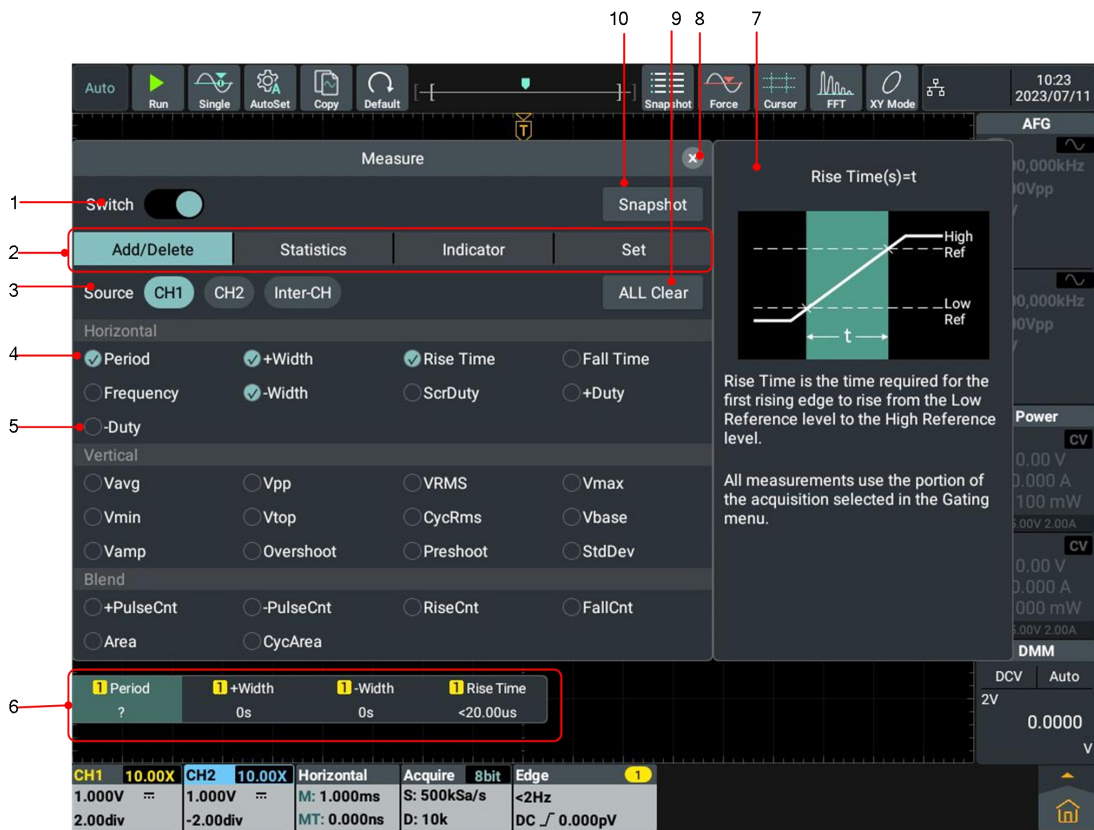

Figure 5- 5:Automatic Measurement

S/N	Descriptions
1	Switch, the current state is On; and the measurement is off when the circle is gray.
2	Setting measuring menu.
3	Select signal source CH1 and CH2 or between channels. Select the corresponding signal source to highlight the signal source and display corresponding measuring type. Current state is CH1 signal source being selected.

<b>4</b>	It indicates that the current measuring type is added.
<b>5</b>	It indicates that the current measuring type is not added.
<b>6</b>	It indicates the display box of current measuring value type and measuring result display box.
<b>7</b>	The currently selected measurement type is interpreted.
<b>8</b>	Click to close measuring menu.
<b>9</b>	Click to delete all added measuring types.
<b>10</b>	Click to display all measuring values of current opened channel.

### Add/Delete

The waveform channel must be opened for measurement. Automatic measurement can not be performed when storing the waveform or calculating double waveforms. In slow sweep, both the cycle and frequency can not be measured.

**For example:** To measure the cycle and frequency of CH1 channel signal, operate according to the following steps:

1. Press **Measure** key and the automatic measurement menu is displayed on the screen.
2. Click the Switch to On state and the circle is highlighted.
3. Click Signal Source **CH1** to highlight it.
4. Click **Period** and **Frequency** in the horizontal measurement, and the circle is checked and highlighted.

The measured values will be automatically displayed at the lower left of the screen. See Number 6 in Figure 5-5.

### Automatic Measurement of Horizontal Parameters

The oscilloscopes provide time parameters auto-measurements include Period, Frequency, Rise Time, Fall Time, +D width, -D width, +Duty, -Duty, and Screen Duty.

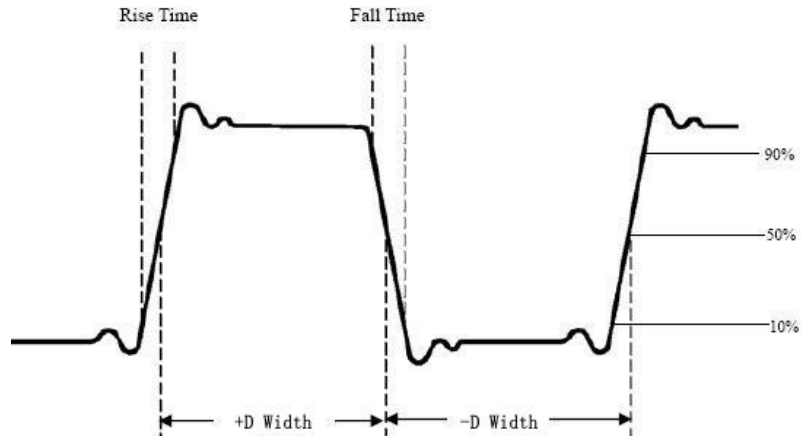

Figure 5-6

**Rise Time:** Time that the leading edge of the first pulse in the waveform takes to rise from 10% to 90% of its amplitude.

**Fall Time:** Time that the falling edge of the first pulse in the waveform takes to fall from 90% to 10% of its amplitude.

**+D width:** The width of the first positive pulse in 50% amplitude points.

**-D width:** The width of the first negative pulse in the 50% amplitude points.

**+Duty:** +Duty Cycle, defined as +Width/Period.

**-Duty:** -Duty Cycle, defined as -Width/Period.

**Screen Duty:** Defines as (the width of the positive pulse)/(Entire period)

### Automatic Measurement of Vertical Parameters

The oscilloscopes provide automatic voltage measurements including Mean, PK-PK, RMS, OverShoot, Max, Min, Vtop, Cycle RMS, Vbase, Vamp, and PreShoot, Standard deviation The following figure illustrates the physical significance of a set of voltage parameters.

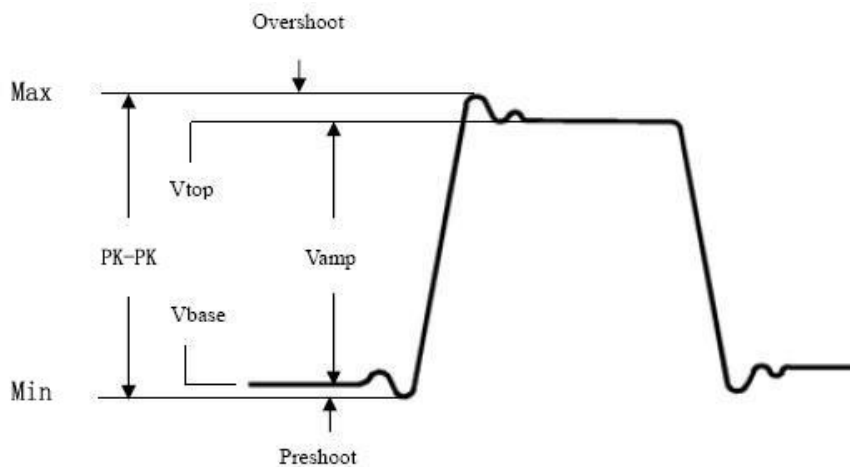

Figure 5-7

**Vavg:** The arithmetic mean over the entire waveform.

**Vpp:** Peak-to-Peak Voltage.

**VRMS:** The true Root Mean Square voltage over the entire waveform.

**OverShoot:** Defined as  $(V_{max}-V_{top})/V_{amp}$ , useful for square and pulse waveforms.

**Vmax:** The maximum amplitude. The most positive peak voltage measured over the entire waveform.

**Vmin:** The minimum amplitude. The most negative peak voltage measured over the entire waveform.

**Vtop:** Voltage of the waveform's flat top, useful for square/pulse waveforms.

**Cycle RMS:** The true Root Mean Square voltage over the first entire period of the waveform.

**Vbase:** Voltage of the waveform's flat base, useful for square/pulse waveforms.

**Vamp:** Voltage between Vtop and Vbase of a waveform.

**PreShoot:** Defined as  $(V_{min}-V_{base})/V_{amp}$ , useful for square and pulse waveforms.

**StdDev:** Calculate the arithmetic square root of the mean of the square of the difference between each data piece of the waveform and its mean.

**Mixed Measurement:**

**+PulseCount** : The number of positive pulses that rise above the mid reference crossing in the waveform.

**-PulseCount** : The number of negative pulses that fall below the mid reference crossing in the waveform.

**RiseEdgeCnt** : The number of positive transitions from the low reference value to the high reference value in the waveform.

**FallEdgeCnt** : The number of negative transitions from the high reference value to the low reference value in the waveform.

**Area** : The area of the whole waveform within the screen and the unit is voltage-second. The area measured above the zero reference (namely the vertical offset) is positive; the area measured below the zero reference is negative. The area measured is the algebraic sum of the area of the whole waveform within the screen.

**Cycle Area** : The area of the first period of waveform on the screen and the unit is voltage-second. The area above the zero reference (namely the vertical offset) is positive and the area below the zero reference is negative. The area measured is the algebraic sum of the area of the whole period waveform.

Note: When the waveform on the screen is less than a period, the period area measured is 0.

**Automatic Measurement of Inter-channel Parameters:**

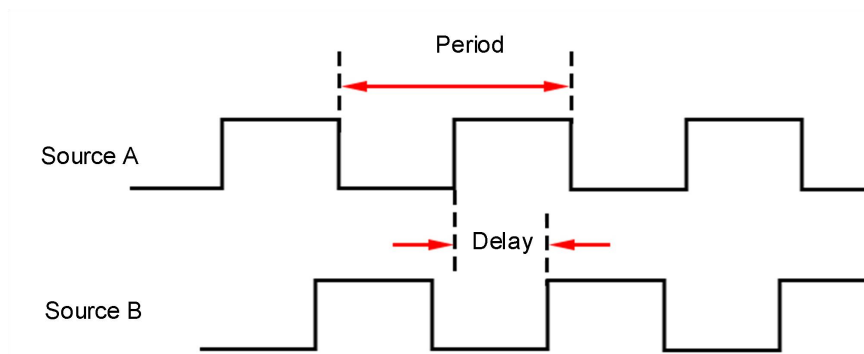

**Note for the following measurements:**

When source A in the menu is set to CH<n>, source A is CH<n>.

When source B in the menu is set to CH<n>, source B is CH<n>.

**Delay(  $\uparrow$  -  $\uparrow$  ):** The time difference between the rising edge of source A and the rising edge of source B at the middle of the threshold. Negative delay indicates that the rising edge of source A occurs after that of source B.

**Delay(  $\downarrow$  -  $\downarrow$  ):** The time difference between the falling edge of source A and the falling edge of source B at the middle of the threshold. Negative delay indicates that the falling edge of source A occurs after that of source B.

**Delay(  $\uparrow$  -  $\downarrow$  ):** The time difference between the rising edge of source A and the falling edge of source B at the middle of the threshold. Negative delay indicates that the rising edge of source A occurs after the falling edge of source B.

**Delay(  $\downarrow$  -  $\uparrow$  ):** The time difference between the lower rising edge of source A and the upper falling edge of source B at the middle value of the threshold. Negative delay indicates that the lower rising edge of source A occurs after the upper falling edge of source B.

**Phase(  $\uparrow$  -  $\uparrow$  ):** The phase difference between the rising edge of source A and the rising edge of source B at the middle value of the threshold is expressed in degrees. Calculation formula is:

$$Phase_{A_R B_R} = \frac{Delay_{A_R B_R}}{Period_{sourceA}} \times 360^\circ$$

Of which,  $Phase_{A_R B_R}$  is phase( $\Psi - \Psi$ ),  $Delay_{A_R B_R}$  is delay( $\Psi - \Psi$ ),  $Period_{sourceA}$  is source A period.

**Phase( $\Psi - \Phi$ ):** The phase difference between the falling edge of source A and the falling edge of source B at the middle value of the threshold is expressed in degrees. Calculation formula is:

$$Phase_{A_F B_F} = \frac{Delay_{A_F B_F}}{Period_{sourceA}} \times 360^\circ$$

Of which,  $Phase_{A_F B_F}$  is phase( $\Phi - \Phi$ ),  $Delay_{A_F B_F}$  is delay( $\Phi - \Phi$ ),  $Period_{sourceA}$  is source A period.

**Phase( $\Psi - \Phi$ ):** The phase difference between the rising edge of source A and the falling edge of source B at the middle value of the threshold is expressed in degrees. Calculation formula is:

$$Phase_{A_R B_F} = \frac{Delay_{A_R B_F}}{Period_{sourceA}} \times 360^\circ$$

Of which,  $Phase_{A_R B_F}$  is phase( $\Psi - \Phi$ ),  $Delay_{A_R B_F}$  is delay( $\Psi - \Phi$ ),  $Period_{sourceA}$  is source A period.

**Phase( $\Phi - \Psi$ ):** The phase difference between the falling edge of source A and the rising edge of source B at the middle value of the threshold is expressed in degrees. Calculation formula is:

$$Phase_{A_F B_R} = \frac{Delay_{A_F B_R}}{Period_{sourceA}} \times 360^\circ$$

Of which,  $PhaseA_FB_R$  is phase( $\Psi - \Phi$ ),  $DelayA_FB_R$  is delay( $\Psi - \Phi$ ),

$Period_{sourceA}$  is source A period.

**FRR:** Time between Source A first rising edge and Source B first rising edge.

**FRF:** Time between Source A first rising edge and Source B first falling edge.

**FFR:** Time between Source A first falling edge and Source B first rising edge.

**FFF:** Time between Source A first falling edge and Source B first falling edge.

**LRR:** Time between Source A first rising edge and Source B last rising edge.

**LRF:** Time between Source A first rising edge and Source B last falling edge.

**LFR:** Time between Source A first falling edge and Source B last rising edge.

**LFF:** Time between Source A first falling edge and Source B last falling edge.

### Statistics

Click statistics in the menu and click switch to open or close the statistics display window. This instrument supports statistics and displays the current value of a number of measurement results, as shown in the figure below

	1 Period
Cur:	1.000ms
Avg:	999.3us
Max:	1.440ms
Min:	998.6us
Dev:	666.6ns

- In the statistics menu, click **Avg & Std Sample Times** Input Box, set the statistics number by pop up keyboard and also can rotate the corresponding multifunction knob to set value. The value range of measurement times is 2 to 1000, default is 2.
- In the statistics menu, click **Reset**, it will clear all measurement of history data and statistics again.

### Indicator

In the Indicator menu, click **Switch**, select open or close Indicator function.

If opening Indicator function, screen will appear one or multiple cursor. Before opening Indicator function, you need to open one automatic measurement parameter at least, cursor number will change by measurement parameters.

### Set

Top/Base: Set the measurement method for the top and bottom values of

the amplitude.

Threshold(Lower Limit<Mid Value<Upper Limit):

- Click **Upper Limit** Input Box set the statistics number by pop up keyboard and also can rotate the corresponding general knob to set value. When the upper limit value is set to less than or equal to the current median value, the interface prompts "exceed the limit value", and the instrument automatically adjusts the upper limit value to make it higher than the median value. The default percentage is 90%, and the default absolute value changes with the vertical setting of the channel.
- Click **Mid Value** Input Box set the statistics number by pop up keyboard and also can rotate the corresponding general knob to set value. The median value is limited by the upper and lower limits, and the default percentage is 50%. The default absolute value varies with the vertical setting of the channel.
- Click **Lower Limit** Input Box set the statistics number by pop up keyboard and also can rotate the corresponding general knob to set value. When the current limit value is set to greater than or equal to the current median value, the interface prompts "exceed limit value", and the instrument automatically adjusts the lower limit value to make it lower than the median value. The default percentage is 10%, and the default absolute value changes with the vertical setting of the channel.
- Click **Default** The instrument restores the upper limit, med value, and lower limit to default values.

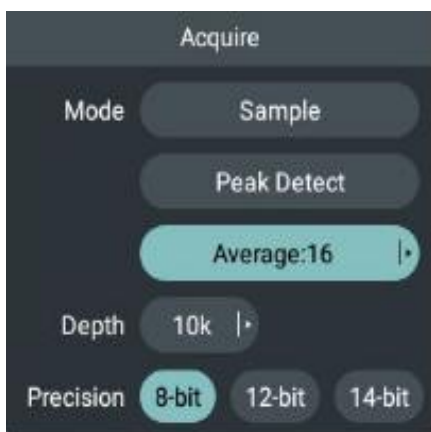

### How to conduct collection setting

Press **Acquire** key or click **Collection** in the function information display bar at the lower part of the screen or click the main menu window to select **Collection** menu, the menu is shown in the figure below:



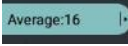

The descriptions of setting menu are shown in the table below:

Menu	Setting	Descriptions
Mode	Sample	General Acquisition mode.
	Peak Detect	Used to detect interference burrs and possibility of reduce confusion.
	Average	Used to reduce random and irrelevant noise in signal, click  to select the average times on the right display box.
Depth	1k 10k 100k 1M 10M	Click  to select the length to be recorded on the right display box.
Precision	8-bit 12-bit 14-bit	Select to set ADC precision.

## How to conduct cursor measurement

Press **Cursor** key or click the main menu window to select **Cursor** menu or click Cursor on the function information display bar at the upper part of the screen, then click the **cursor** in the function information bar at the lower left of the screen, the menu is shown in the figure below:

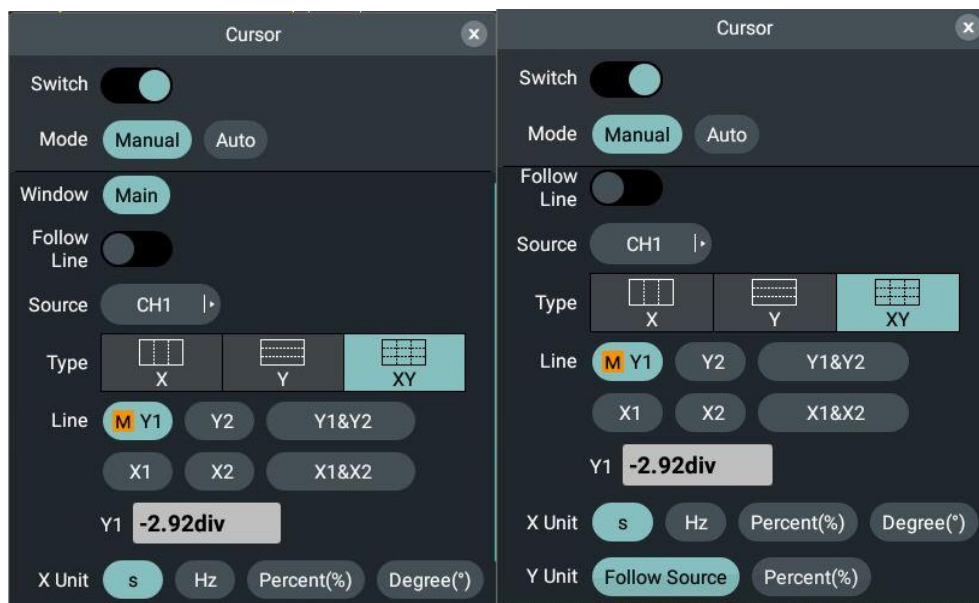

Press **Cursor** key and the cursor measurement function menu is displayed on the screen. Then press **Cursor** key to close the cursor function menu.

## Cursor Measurement in General Mode:

The descriptions of **cursor measurement menu** are shown in the table below:

Menu		Setting	Descriptions
Switch			Open or close the cursor measurement.
Mode		Manual Auto	Select Cursor Mode. When Auto Mode is selected, the position of the horizontal cursor is automatically set to the intersection of the vertical cursor and the waveform.
Window		Main Other	Measure the main waveform area; Measure other waveform areas. Note: Only available in XY、Zoom、FFT mode.
Follow Line			Enable or disable the cursor measured value moving with the cursor line.
Source		Selected Waveform CH1 CH2 Math	Select the waveform channel to be measured by the cursor.
Type		X Y XY	Display time measurement cursor and menu Display voltage measurement cursor and menu Display time and voltage measurement cursor and menu.
Line		X1 X2 X1&X2  Y1 Y2 Y1&Y2  Input Box	Select X1 vertical cursor line; Select X2 vertical cursor line; Select X1 and X2 vertical cursor lines simultaneously. Select Y1 horizontal cursor line; Select Y2 horizontal cursor line; Select Y1 and Y2 horizontal lines simultaneously. Select a cursor line and turn <b>General</b> knob or drag the cursor line with the finger to move the cursor line. Click Input Box to set the cursor position required.
Unit	X Unit	s Hz Percent(%)	Select the display unit of cursor measurement.

## 5. Use the Oscilloscope

		Degree(°)	
	Y Unit	Follow Source Percent(%)	The display unit of Y cursor display value is subject to the unit of signal source (V.A.W.U) or the percentage.

To conduct cursor measurements of CH1 time and voltage, perform the following operating steps:

1. Press **Cursor** key to pop up cursor measurement menu.
2. Click **Switch**. When the switch label is highlighted on the right, it is enabled. The cursor reading will be displayed in the increment window at the lower left of the waveform display area.
3. Click window in **Signal Source** menu below to select **CH1**.
4. Set Cursor Type
  - Click **X** in the type menu to highlight it, and two yellow dotted lines X1 and X2 are displayed in the vertical direction of the screen;
  - Click **Y** in the type menu to highlight it, and two yellow dotted lines Y1 and Y2 are displayed in the horizontal direction of the screen;
  - Click **XY** in the type menu, two yellow dotted lines X1 and X2 in the vertical direction and two yellow dotted lines Y1 and Y2 in the horizontal direction are displayed in the screen.
5. Set Cursor Line
  - Click **Y1** or **Y2** in the Cursor Line menu, turn **General** knob to move the cursor lines **Y1** or **Y2** up and down; select **Y1&Y2** and turn **General** knob to move the cursor lines Y1 and Y2 up and down simultaneously;
  - Click **X1** or **X2** in the Cursor Line menu, turn **General** knob to move the cursor lines **X1** or **X2** left and right; select **X1&X2** and turn **General** knob to move the cursor lines X1 and X2 left and right simultaneously.
6. Press HOR key or turn on the amplification mode switch to enter waveform amplification mode. In the cursor measurement menu below, select Waveform Area as the Main Waveform Area or Zoom Waveform Area to display the cursor lines in the main waveform area or Zoom waveform area.

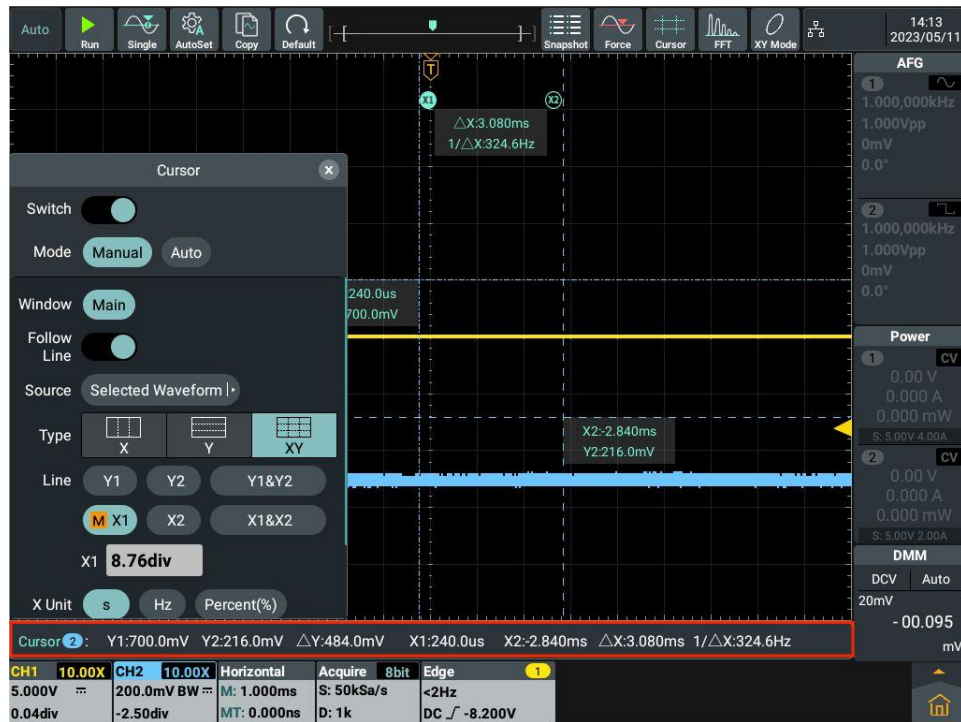

Figure 5- 8:Time &amp;Voltage Cursor Measurement

## Use gestures to move the cursor line

For operating touch screen in cursor measurement, see “Other touch screen operations” in Page25

## Cursor Measurement in FFT Mode:

To conduct the cursor measurement in FFT mode, perform the following operating steps:

1. Click the shortcut key **FFT** at the upper part of the screen and FFT Information Box is displayed at the lower part of the screen; click Information Box and FFT Setting box is displayed on the screen; then select amplitude unit in the **Vertical Units** (Vrms 、 dB、 Radians 、 Degrees).
2. Press **Cursor** key to pop up the cursor measurement menu.
3. Click **Switch**. When the switch label is highlighted on the right, it is enabled. The cursor reading will be displayed in the increment window at the lower left of the waveform display area.
4. Click **Main Waveform Area** as **FFT Waveform Area** in the cursor measurement menu below.
5. Set **Cursor Type**
  - Click **X** in the type menu to highlight it, and two yellow dotted lines X1 and X2 are displayed in the horizontal direction of the screen;

- Click **Y** in the type menu to highlight it, and two yellow dotted lines Y1 and Y2 are displayed in the horizontal direction of the screen;
  - Click **XY** in the type menu and two yellow dotted lines X1 and X2 in the vertical direction and two yellow dotted lines Y1 and Y2 in the horizontal direction are displayed on the screen.
6. Set Cursor Line
- Click **Y1** or **Y2** in the cursor line menu and turn **General** knob to move the cursor lines **Y1** or **Y2** up and down; Select **Y1&Y2** and turn General knob to move two cursor lines **Y1** and **Y2** up and down simultaneously;
  - Click **X1** or **X2** in the cursor line menu and turn **General** knob to move the cursor lines **X1** or **X2** left and right; select **X1&X2** and turn **General** knob to move two cursor lines **X1** and **X2** left and right simultaneously.
  - Select **Waveform Area** as the **Main Waveform Area** in the cursor measurement menu below to display the cursor line in the main waveform area.

### Cursor Measurement in XY Mode:

To conduct the cursor measurement in XY mode, perform the following operating steps:

1. Click the shortcut key XY at the upper part of the screen that can directly open XY mode.
2. Press **Cursor** key to pop up the cursor measurement menu.
3. Click **Switch**. When the switch label is highlighted on the right, it is enabled. The cursor reading will be displayed in the increment window at the lower left of the waveform display area.
4. Click **Main Waveform Area** as **XY Waveform Area** in the cursor measurement menu below.
5. Set **Cursor Type**
  - Click **X** in the type menu to highlight it, and two yellow dotted lines X1 and X2 are displayed in the horizontal direction of the screen;
  - Click **Y** in the type menu to highlight it, and two yellow dotted lines Y1 and Y2 are displayed in the horizontal direction of the screen;
  - Click **XY** in the type menu and two yellow dotted lines X1 and X2 in the vertical direction and two yellow dotted lines Y1 and Y2 in the horizontal direction are displayed on the screen.
6. Set Cursor Line
  - Click **Y1** or **Y2** in the cursor line menu and turn **General** knob to move the cursor lines **Y1** or **Y2** up and down; Select **Y1&Y2** and turn General knob to move two cursor lines **Y1** and **Y2** up and down simultaneously;
  - Click **X1** or **X2** in the cursor line menu and turn **General** knob to move the cursor lines **X1** or **X2** left and right; select **X1&X2** and turn **General**

- knob to move two cursor lines **X1** and **X2** left and right simultaneously.
- Select **Waveform Area** as the **Main Waveform Area** in the cursor measurement menu below to display the cursor line in the main waveform area.

## How to realize waveform operation function



**Waveform operation** functions include addition, subtraction, multiplication, division, integration, differentiation, square root and custom function operations for Channel 1 and Channel 2 waveforms. Press **Math** key to display the waveform calculation menu below.

The waveform calculation setting box is shown in the figure below:





Table for Operating Functions of **Waveform Calculation**:

Menu	Setting	Descriptions
<b>Switch</b>		Open or close the waveform calculation.
<b>Type</b>	<b>Basic</b>	Waveform calculation of simple addition, subtraction, multiplication and division for CH1 and CH2;
	<b>Advanced</b>	Advanced waveform calculation for CH1 and CH2, such as integration, calculus, square roots or custom function operations.
<b>Expression</b>	<b>CH1  ▶</b>	Select CH1 or CH2 signal source.
	<b>+  ▶</b>	Select operation sign.
	<b>CH1  ▶</b>	Select CH1 or CH2 signal source.
<b>Display</b>		Open or close <b>Math</b> operation formula.

<b>Scale</b>		Turn <b>General</b> knob to adjust the vertical gear of <b>Math</b> waveform.
<b>Vertical</b>		Click <b>Numeric Input Box</b> to directly input the vertical position of the <b>Math</b> waveform to be set and click the unit to confirm; or click Gear Input Box (- or +) or turn <b>General</b> knob to set the vertical position of <b>Math</b> waveform to be set, click < > or press   to move the cursor and select the digit to be set.

### Waveform Calculation



Take Channel 1 + Channel 2 as an example, the operating steps are as follows:

1. Press **Math** key and the waveform calculation menu is displayed below;
2. Click **Switch**. When the switch label is highlighted on the right, it is enabled. The pink waveform M will be displayed on the screen.
3. Click **Basic** in the menu to highlight it.
4. Select **CH1| ▶** in the menu to select **CH1**.
5. Select **+| ▶** in the menu to select **+**.
6. Select **CH1| ▶** in the menu to select **CH2**.
7. Click **Display**. When the switch label is highlighted on the right, it is enabled. The pink Math and formula will be displayed at the lower left corner of the screen.
8. Click the Numeric Display Box of **Scale** in the menu and turn **General** knob to adjust the vertical gear of Math waveform.
9. Click **Vertical** in the menu, click Numeric Input Box to directly input the vertical position of **Math** waveform to be set and click the unit to confirm; or click Gear Input Box (- or +) or turn **General** knob to set the vertical position of **Math** waveform to be set and click < > or press   to move the cursor and select the digit to be set.

### Custom Function Operation

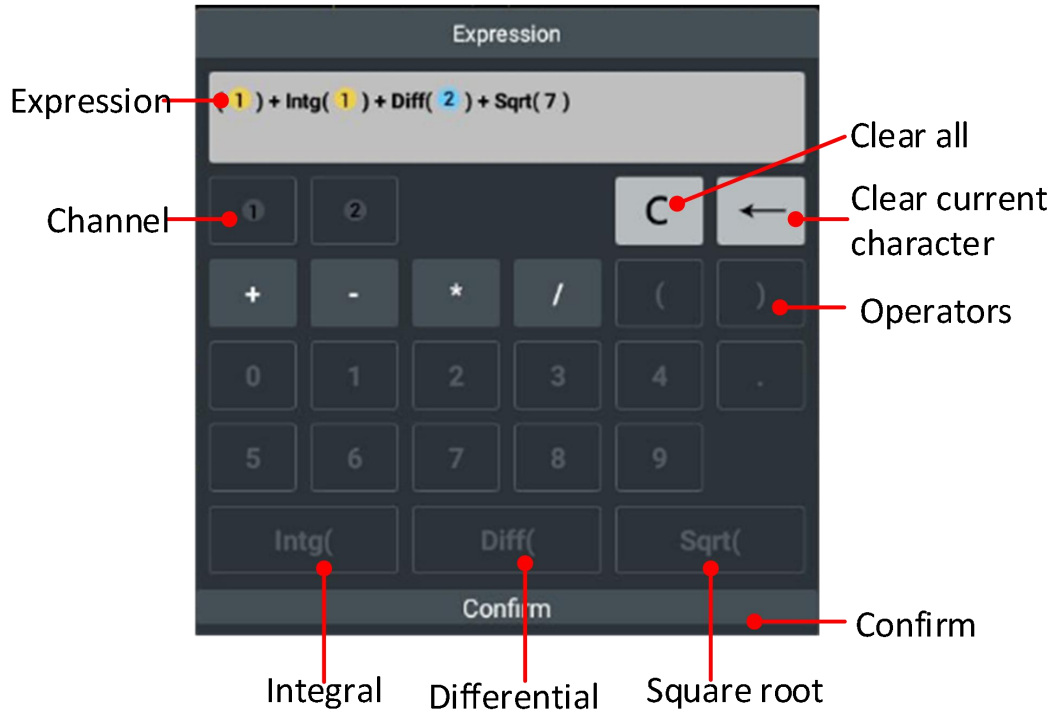
1. Press **Math** key and the waveform calculation menu is displayed below.
2. Click **Switch**. When the switch label is highlighted on the right, it is enabled. The pink waveform M will be displayed on the screen.
3. Click **Advanced** in the menu to highlight it.
4. Click **Expression** Display Box to pop up expression input soft keyboard on the screen



5. Create the expression, then select **Confirm** in the keyboard to implement.
6. Click **Display**. When the switch label is highlighted on the right, it is enabled. The pink Math and formula will be displayed at the lower left corner of the screen.
7. Click the Numeric Display Box of **Scale** in the menu and turn General knob to adjust the vertical gear of Math waveform.
8. Click **Vertical** in the menu, click **Numeric Input Box** to directly input the vertical position of Math waveform to be set and click the unit to confirm; or click Gear Input Box (- or +) or turn General knob to set the vertical position of Math waveform to be set and click < > or press   to move the cursor and select the digit to be set.

### How to set display system

Press **Display** key or click Display in other modules of main menu window  at the lower right of the screen.

The descriptions of **Display Setting Menu** are shown in the table below:

Menu	Setting	Descriptions
Type	Point Vector	Only display the acquisition points. Vector filling displays the space between adjacent acquisition points in the middle.



## 5. Use the Oscilloscope

Persist	Close 1Second 2Seconds 5Seconds Infinity	Select the time of duration. Note:Currently support CH1, CH2, FFT, XY, DIR, waveform operation models.
	Clear	Erase previously collected results from the display. The oscilloscope will start cumulative collection again.
Wave Intensity		Slide adjusts the current wave intensity. Drag the slider to the right of Wave Intensity item to set waveform brightness. The adjustable range is 10% to 100%.
Color Grade		Open or close Color Grade function.
Low refresh rate		Open or close Low refresh rate. You can observe the waveform changing at a low refresh rate .
Grid	FULL GRID HALF NONE	Select the current screen grid type. <ul style="list-style-type: none"> <li>• FULL: Indicates that the number of display grids on the screen is full. Open background grid, Indicates that the number of display grids on the screen is full. Open background grid</li> <li>• DRID: Point grid, representing the display grid on the screen in addition to the grid where the scale line is located, every two adjacent scale lines between two small horizontal lines formed a line of points and lines.</li> <li>• HALF: Semi-grid, indicating that the display grid on the screen closes part of the background grid, leaving only the main grid.</li> <li>• NONE: No grid indicates that all background grids are closed on the screen.</li> </ul>
Grid Brightness		Slide adjusts the current grid brightness. Drag the slider to the right of Grid Brightness item to set grid brightness. The adjustable range is 0% to 100%.
Window Transparency		Slide adjusts the current window brightness. Drag the slider to the right of Window Transparency item to set window brightness. The adjustable range is 0% to 100%.

### Afterglow:

When afterglow function is used, the afterglow display of image tube can be simulated. The color of the original data retained is gradually lightened and that of new data becomes brighter.

(1) Press **Display** key.

- (2) Click **Type** in the menu to set it as **Point** or **Vector**.
- (3) Select the duration in the duration display box of the **Persist**, including **Close, 1 Second, 2 Seconds, 5 Seconds** and **Infinity**. When the duration is **Infinity**, the recording point is maintained until the control value is changed. Select **Close** to close the afterglow and clear the display.
- (4) Select **Clear** in the menu to erase previously collected results from the display, and the oscilloscope will start cumulative collection again.

### Color Grade:

The color temperature display function uses the color level to indicate the frequency of waveform occurrence. Warmer colors such as red/yellow indicate more frequent waveforms, while cooler colors such as blue/green indicate less frequent waveforms.

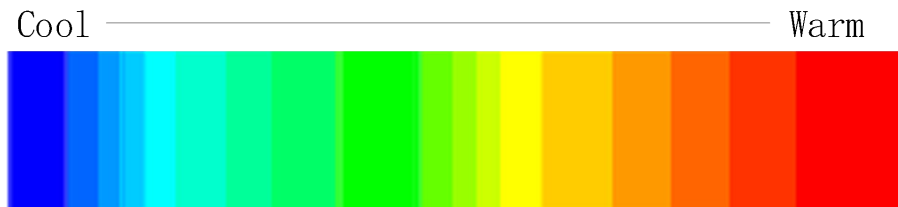

- (1) Press **Display** table button.
- (2) Click Color Grade in the menu, when the switch label is highlighted on the right, it is enabled, click again to close the Color Grade.

### How to set XY mode

After XY mode is selected, both Channel 1 and Channel 2 are opened, and one waveform amplitude is displayed relative to another. **CH1** is displayed on the horizontal axis and **CH2** is displayed on the vertical axis. The oscilloscope uses the untriggered acquisition mode with the data displayed as light spot.

### Operations of various control buttons are as follows:

- Use **Vertical Gear** and **Vertical Displacement** knob of Channel 1 to set the gear and position in horizontal direction.
- Use **Vertical Gear** and **Vertical Displacement** knob of Channel 2 to set the gear and position in vertical direction.

### In the XY mode, the following functions are not available:

- Mathematical operation waveform
- FFT
- DIR
- Pass/Fail
- FRA

Operating Steps:

- (1) Click the main menu window .
- (2) Select **XY Mode** in other menu of Oscilloscope Menu and select **Switch** in Menu Display Box to enable it.
- (3) Select **Full Screen to On** in the Menu Display Box to open the full screen view of XY mode.

## How to save and print

Press **Save** panel key or click **Save** menu in main menu window, save oscilloscope waveform and picture, set to USB or internal memory by operating save function menu; operate print in the Save function menu to print the image displayed on the oscilloscope screen.

The descriptions of Save Function Menu are as shown in the table below:

Menu	Setting		Descriptions
Save	Type	Wave Image Set	Select the function menu required.
	When the type is <b>Wave</b> , the menu shows as following:		
	Path	Internal External	Select the save path. Save in internal or external USB storage.
	Format	Csv Zip Matlab	Select the waveform save format.
	Source	CH1 CH2	Select the waveform to be saved, it is available to save CH1 and/or CH2 waveforms. (When a channel is not open, it can not be saved)
	Name		Save the wave by editing the file name or the system default file name.
	Save		Save current waveform.
	When the type is <b>Image</b> , the menu shows as following:		
	Path	Internal External	Select the save path. Save in internal or external USB storage.
	PreView		Click to open the browse screen to save the picture.
	Format	Bmp Png Jpg Tif	Select the save format of current screen picture.
	Inverse		Enable or disable picture save background; when the color inverse is enabled, use the white background to save the picture.
	Time		Open or close the time for printing images.

			When enabled, the printed image will display the specific printing time of the image in the lower right corner of the image.
	Name		Save the image by editing the file name or the system default file name.
	Save		Save current waveform.
	When the type is <b>Set</b> , the menu shows as following:		
	Set	User0 . . . User9	Set storage location.
	Save		Save the current parameter settings of the oscilloscope to the internal memory.
	Load		Calls the settings saved at the current storage location.
	Rename		Rename the currently saved parameter. Click on the Rename Input Box and enter the string directly through the alphabet keyboard that pops up.
Print	Inverse		Open or close the save background for the printed image. When inverting color is opening , the image will be printed with a white background.
	Time		Open or close the time for printing images. When enabled, the printed image will display the specific printing time of the image in the lower right corner of the image.
	Area	Full Screen Waveform Area	Sets the type to print the current screen image. Full Screen:Print the full screen image of the oscilloscope; Waveform Area:Print an image of the waveform area on the oscilloscope screen.
	Help		Click and go to the official website to obtain the printer installation package.
	Print		Click and select printer for image printing.

## How to print screen images

To print the image displayed on the instrument screen, follow the steps below:

1、 Press **Save** button or click menu window, start print operation, as shown in the following picture.

A: Click **Save** menu;

## 5. Use the Oscilloscope

B: Click **Print** ;

C: Click **Help** button will pop up Print Help window;

D: Click the link go to official website to install print app.

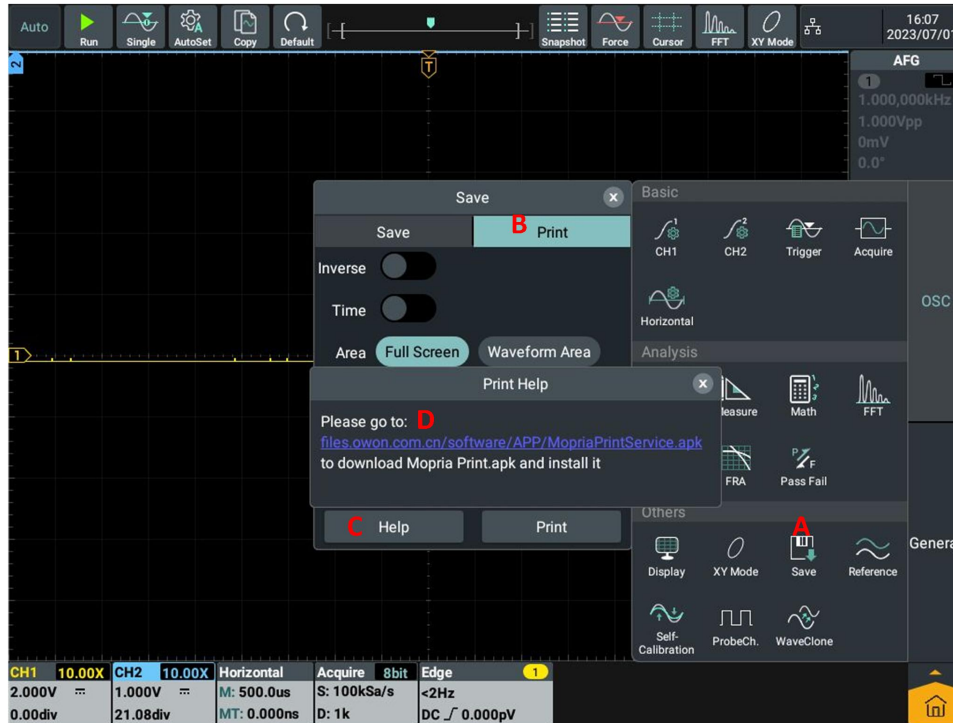

2、 In official website install print app, steps as shown in Figure1 to Figure 5.

① Click download to download installation package, as shown in Figure 1.

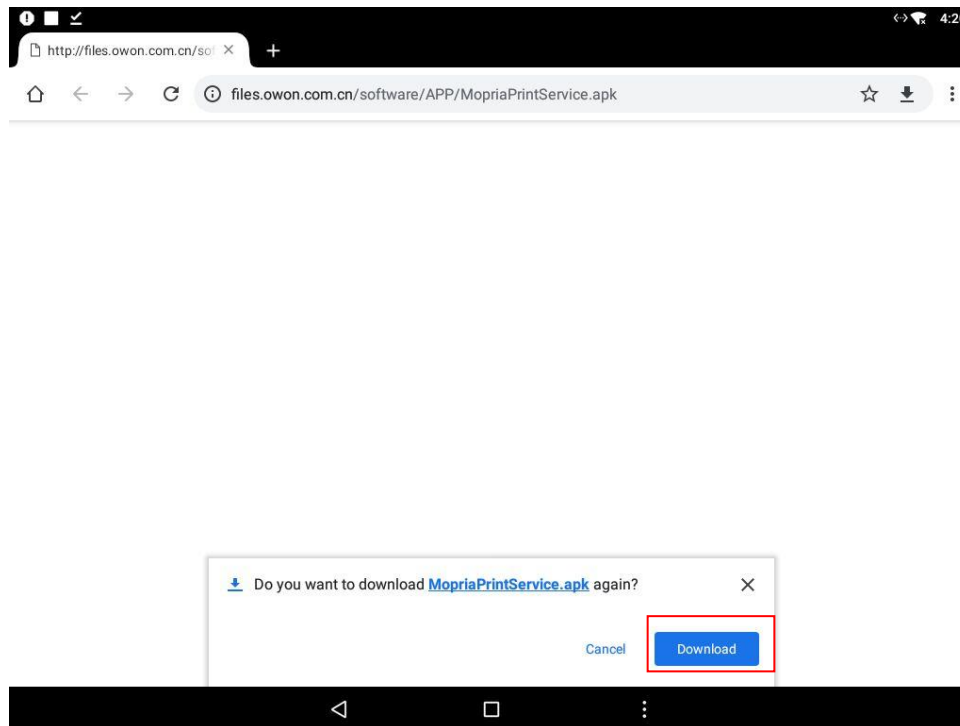

Figure 1

## 5. Use the Oscilloscope

② Click to open installation package, as shown in Figure 2.

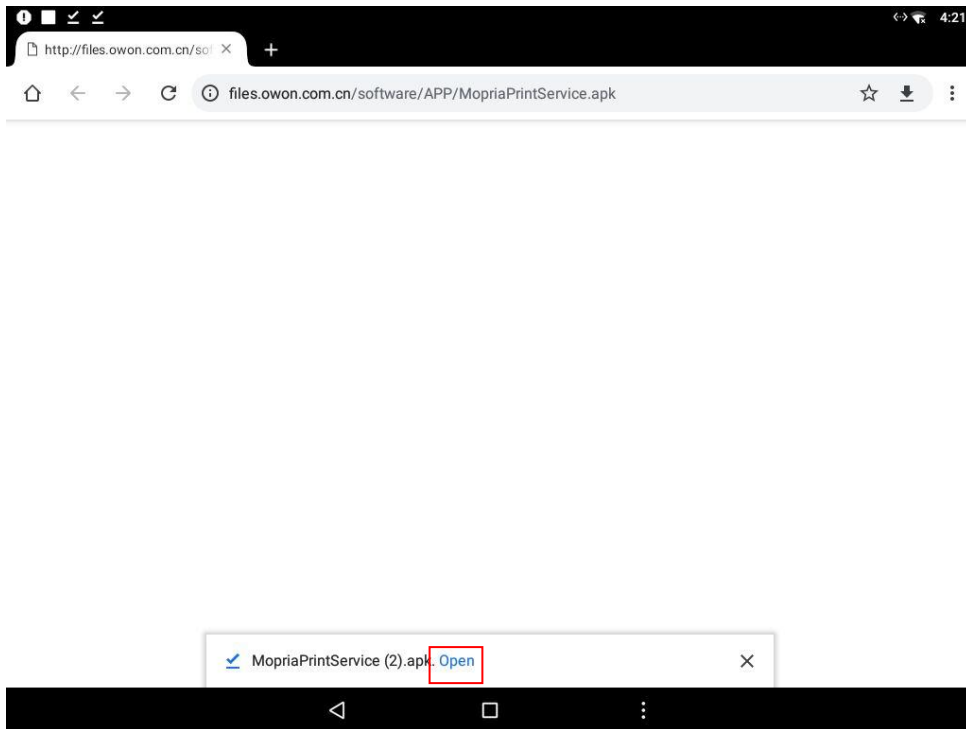

Figure 2

③ Click install, start to install print app, as shown in Figure 3.

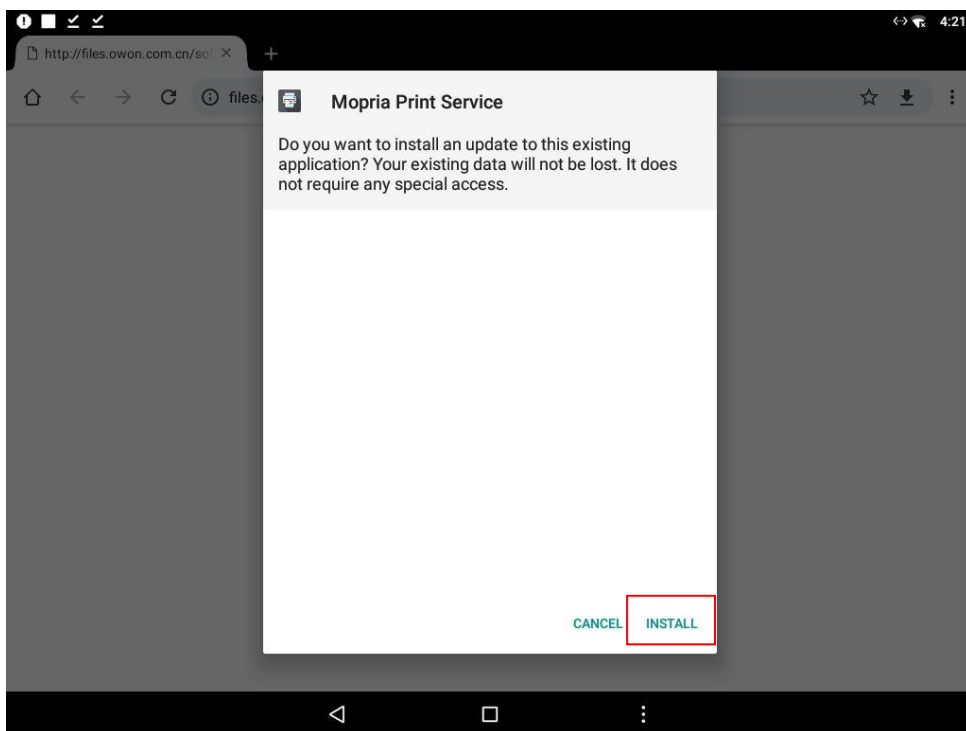

Figure 3

④ Software install produce, as shown in Figure 4.

## 5. Use the Oscilloscope

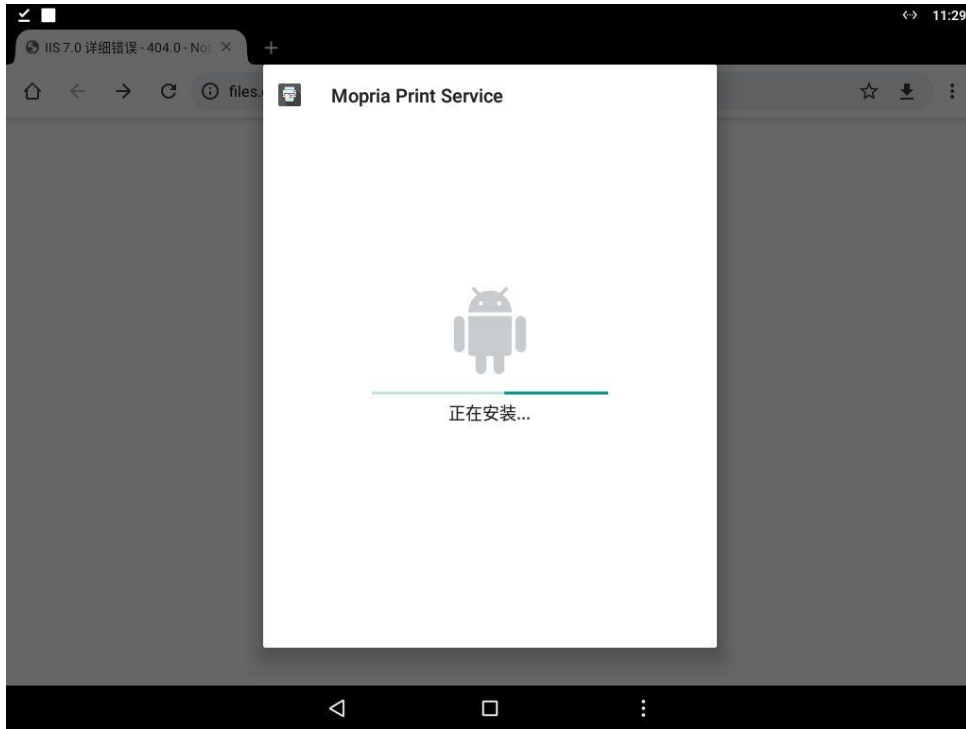

Figure 4

⑤ After install success, click open can open print app. As shown in Figure 5.

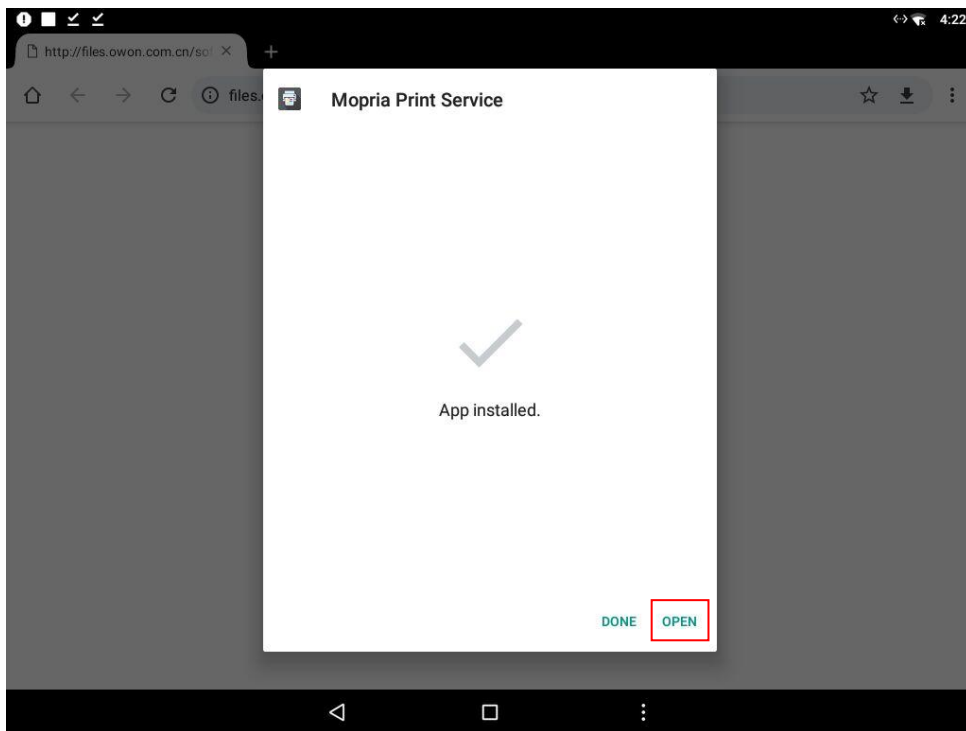

Figure 5

3、 Open the installed printing software, as shown in Figure 6. Go to the last page and check "Agree" license agreement and privacy policy. Click "I agree" to start using the software, as shown in Figure 7.

## 5. Use the Oscilloscope

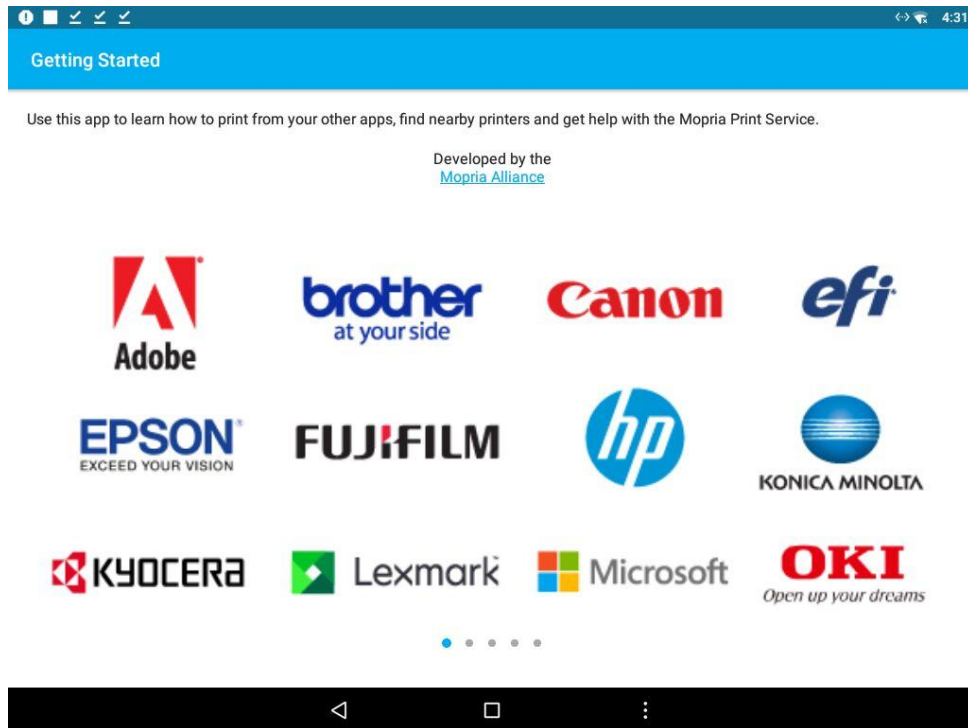

Figure 6

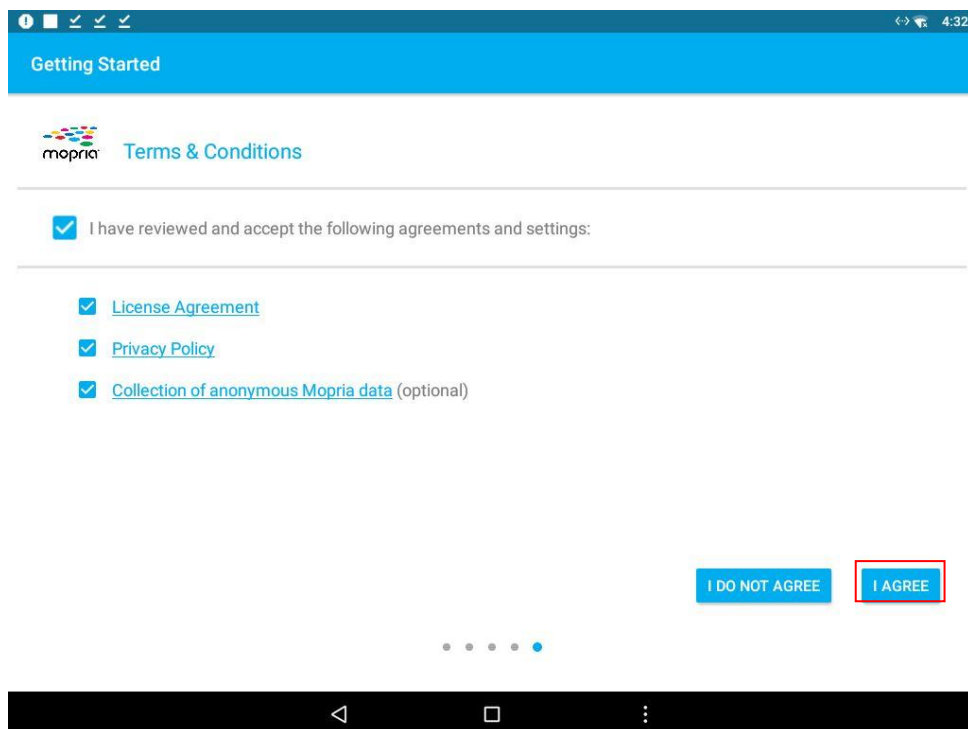

Figure 7

4、 After entering the printing software interface, click "Enable Wi-Fi to see nearby printers" to connect the printer's Wi-Fi, as shown in Figure 8. The Wi-Fi connection is successful, as shown in Figure 9.



## 5. Use the Oscilloscope



Figure 8

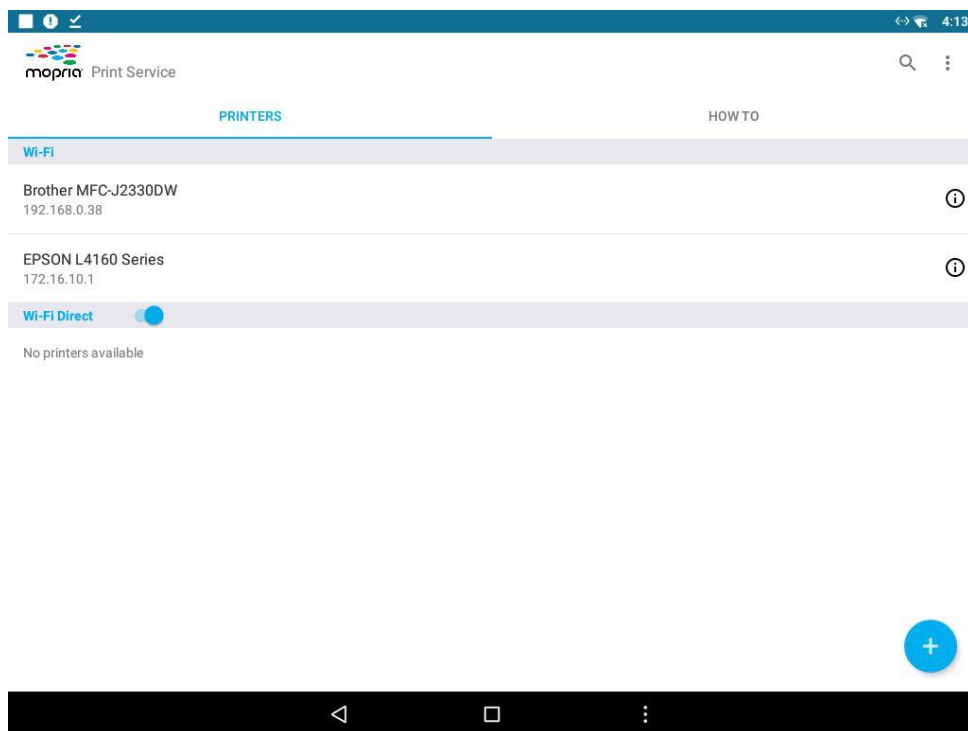
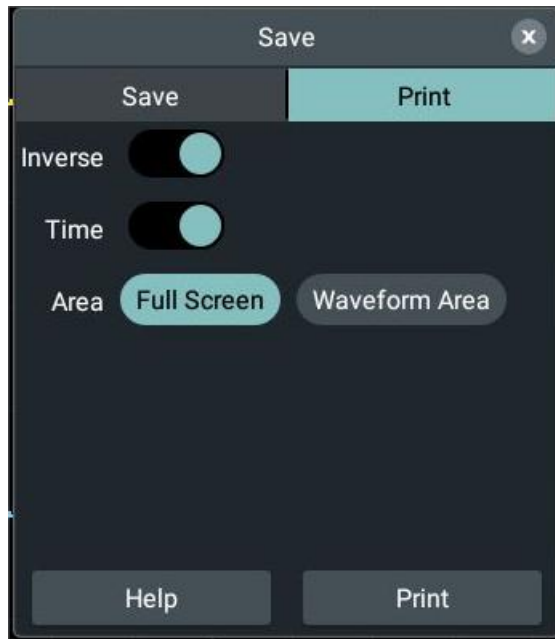

Figure 9

5、 In the menu below, set the printing parameters. Click to open **Inverse** , the image will be printed with a white background. Click to open Time, the image will display specific printing time of the image. Select printing area: **Full Screen** or **Waveform Area**. After setting the parameters, click "Print" to enter the print interface, as shown in the picture below.

## 5. Use the Oscilloscope



6、 After connecting the printer to the instrument and setting the print parameters, clicking **Print** will print the screen image of the currently selected area. As shown in the following picture.

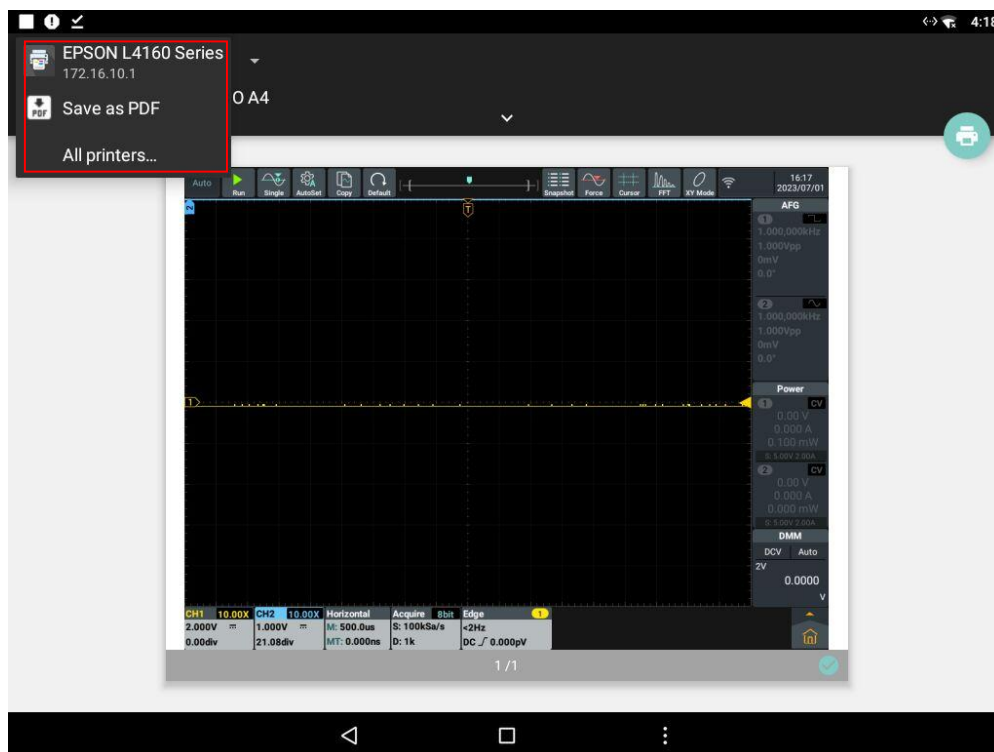

7、 Click the printer to set the number of copies, paper size, print color, print reverse, and print page. Click the print icon to print the image, as shown below.

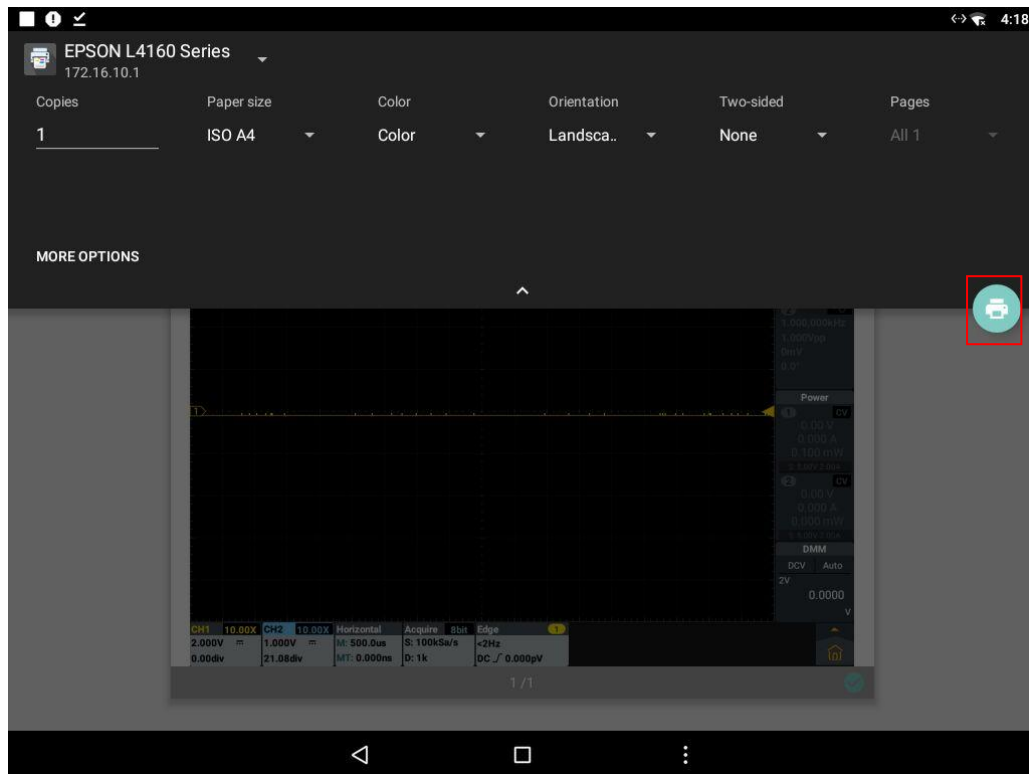

Note: Image printing can only be printed over a network connection, USB connection is not valid.

### USB Flash Drive Requirements

System-supported USB flash drive format: The file system type is FAT32 and the size of the allocation unit can not exceed 4K. Large-capacity USB flash drive is supported. If the USB flash drive can not be used normally, format it according to the above requirements and try again. There are two ways to format a USB flash drive, namely format by using built-in function of computer system and formatting software. (USB flash drive not less than 8G can only be formatted by the second method)

### Use system-provided function to format the USB disk

1. Connect the USB disk to the computer.
2. Right click **Computer**- → **Manage** to enter Computer Management interface.
3. Click Disk Management menu, and information about the USB disk will display on the right side with red mark 1 and 2.

## 5. Use the Oscilloscope

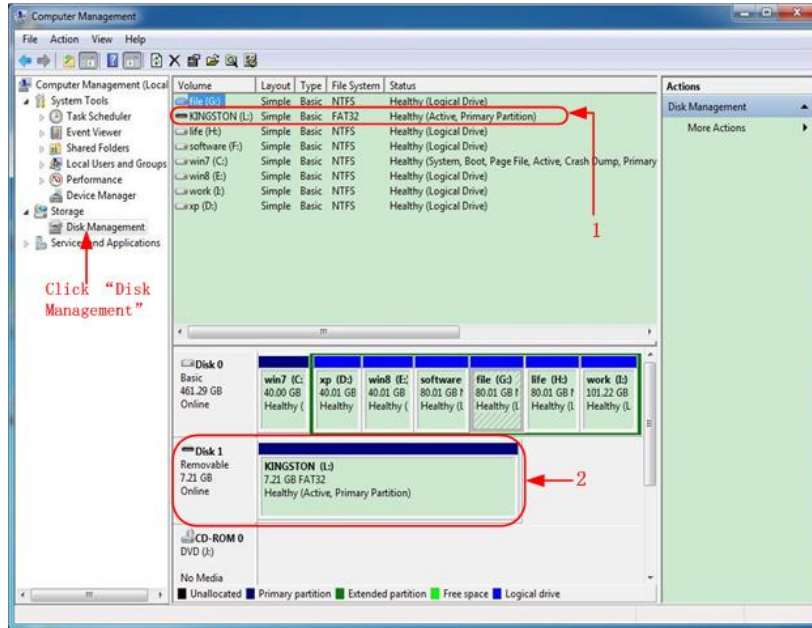

Figure 5-9: Disk Management of computer

- Right click 1 or 2 red mark area, choose **Format**. And system will pop up a warning message, click **Yes**.

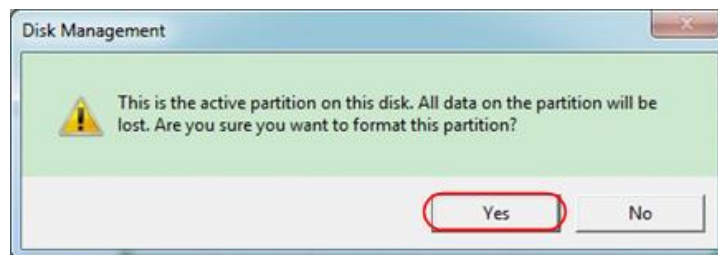

Figure 5-10: Format the USB disk warning

- Set File System as FAT32, Allocation unit size 4096. Check "**Perform a quick format**" to execute a quick format. Click **OK**, and then click **Yes** on the warning message.

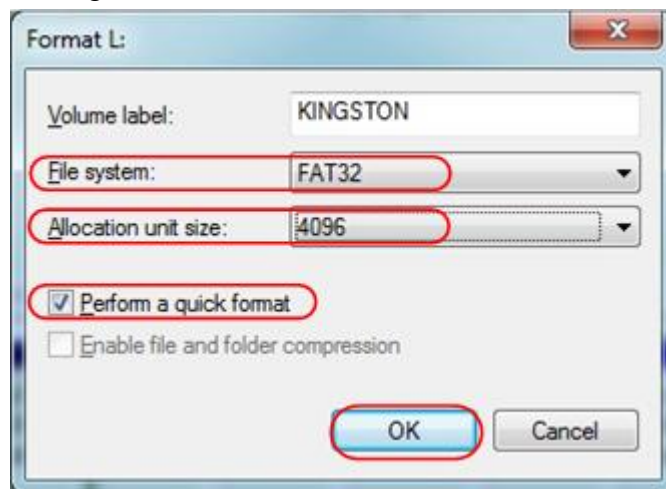

Figure 5-11: Formatting the USB disk setting

6. Formatting process.

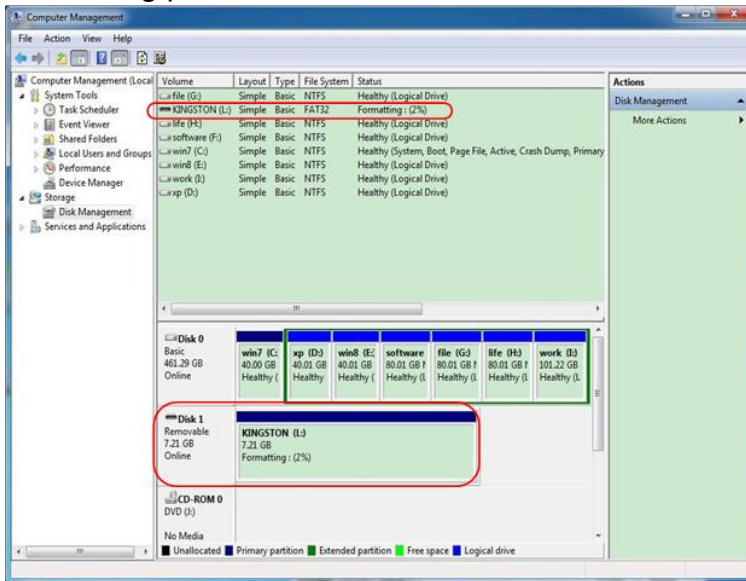

Figure 5- 12:Formatting the USB disk

7. Check whether the USB disk is FAT32 with allocation unit size 4096 after formatting.

**Use Minitool Partition Wizard to format**

Download URL: <http://www.partitionwizard.com/free-partition-manager.html>

**Tip:** There are many tools for the USB disk formatting on the market, just take Minitool Partition Wizard for example here.

1. Connect the USB disk to the computer.
2. Open the software **Minitool Partition Wizard**.
3. Click **Reload Disk** on the pull-down menu at the top left or push keyboard F5, and information about the USB disk will display on the right side with red mark 1 and 2.

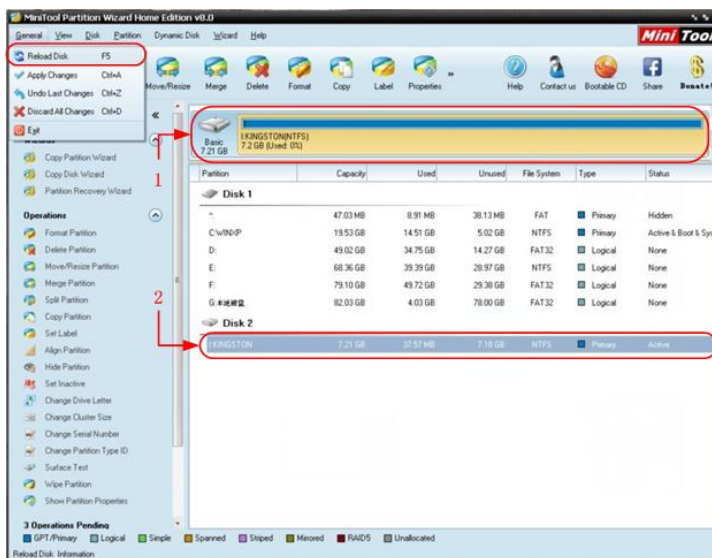

Figure 5- 13:Reload Disk

- Right click 1 or 2 red mark area, choose **Format**.

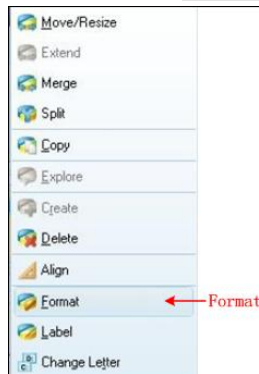

Figure 5- 14: Choose format

- Set File System FAT32, Cluster size 4096. Click **OK**.

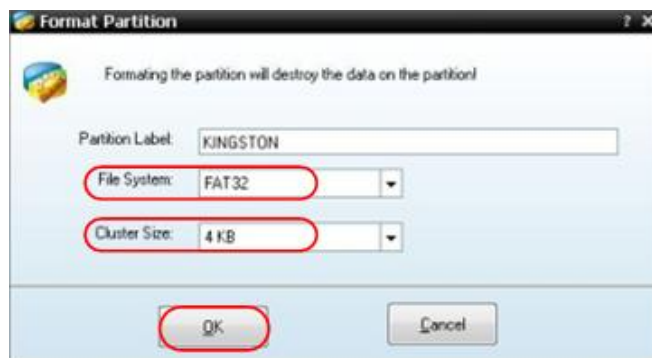

Figure 5- 15:Format setting

- Click **Apply** at the top left of the menu. Then click **Yes** on the pop-up warning to begin formatting.



Figure 5- 16:Apply setting

- Formatting process



Figure 5- 17:Format process

8. Format the USB disk successfully

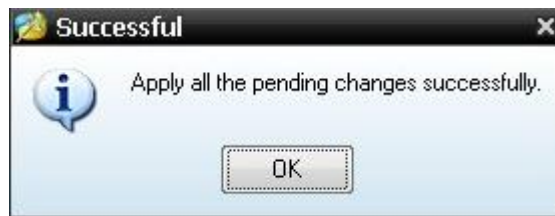

Figure 5- 18: Format successfully

## How to conduct system function setting

Press **Settings** key in the front panel oscilloscope area, including two modules: oscilloscope module and general module function menu window.

### Oscilloscope

The oscilloscope module is composed of basic function module, analytical function module and other modules.

**Basic Function Module contains: CH1, CH2, Trigger, Collection and Horizontal.**

For settings of CH1 and CH2 function parameters, refer to “How to set the vertical system ” in Page 28.

For settings of trigger function parameters, refer to “How to set trigger” in Page35.

For settings of collection function parameters, refer to “How to conduct collection setting” in Page 66.

For settings of horizontal function parameters, refer to “How to set horizontal system” in Page 32.

**Analytical Function Module contains: Cursor, Measure, Waveform Calculation, FFT and DIR, FRA, Pass Fail.**

For settings of cursor function parameters, refer to “How to conduct cursor measurement” in Page 67.

For settings of measurement function parameters, refer to “How to conduct automatic measurement ” in Page 58.

For settings of waveform calculation function parameters, refer to “How to realize mathematical operation function” in Page 72.

## How to conduct FFT Settings

FFT decomposes the signal into component frequencies, and the oscilloscope uses these component frequencies to display the graph of signal frequency domain, which corresponds to the standard time domain graph of the oscilloscope. Then match these frequencies with known system frequencies, such as the system clock, oscilloscope or power supply.

The FFT operation of this instrument can convert 8192 data points of the time domain waveform into frequency domain signal (the recording length of the acquisition shall be set to 10K points or above). And the final FFT spectrum contains 4096 points from DC (0Hz) to Nyquist frequency.

The FFT setting interface is shown as follows:

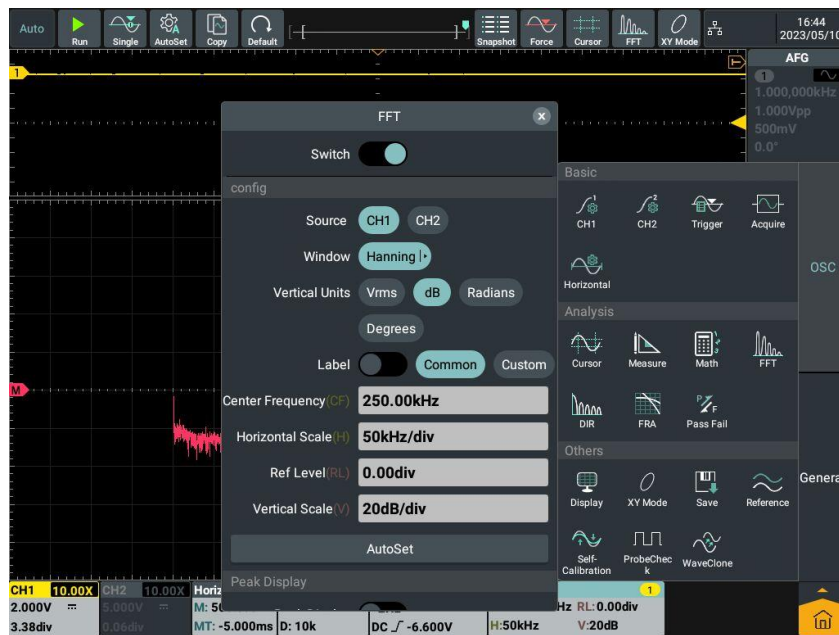



## 5. Use the Oscilloscope

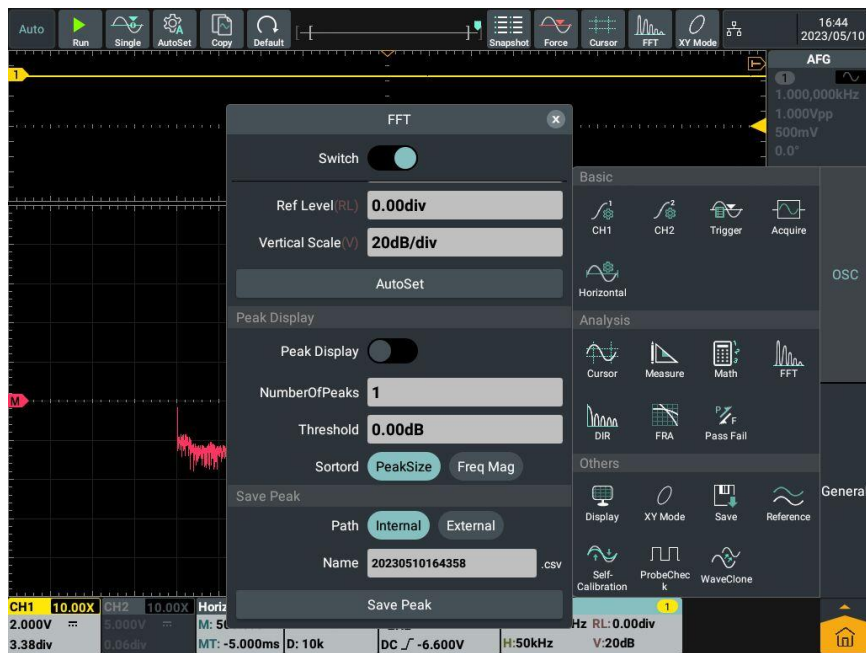

FFT operating steps are as follows:



1. Click FFT in the analytical module from the main menu window  at the lower right of the screen.
2. Click **Switch** at the FFT Menu Setting window displayed on the screen; when the switch label is highlighted on the right, it is enabled. The pink waveform M will be displayed on the screen (It is also available to click FFT shortcut softkey at the upper part of the screen).
3. Click the signal source **CH1** in the menu.
4. Click **Rectangle** in the menu and select the window type to be used from the displayed window.
5. Click **Vertical Unit** in the menu and select **Vrms, dB, Radians** or **Degrees**.
6. Click **Label**, when the switch label is highlighted on the right, it is enabled. You can choose common or custom label type.
7. Click **Center Frequency** Numeric Display Box and set the value required.
8. Click **Horizontal Scale** Numeric Display Box and set the value required.
9. Click **Ref Level** Numeric Display Box and set the value required.
10. Click **Vertical Scale** Numeric Display Box and set the value required.
11. Click **AutoSet**, in the FFT display can observe suitable waveforms .
12. Click **Peak Display**, when the switch label is highlighted on the right, it is enabled. A peak display list appears at the top left of the screen. The number of lists is determined by the number of peaks and the threshold.





The peak display list is displayed at the top left of the waveform.

13. Click **NumberOfPeaks** Numeric Display Box , set the value required and setting range is 0 to 5.
14. Click **Threshold** Numeric Display Box and set the value required. The threshold range is related to the current FFT gear and offset.
15. Click **Sortord** and select the sortord type PeakSize or Freq Mag.
16. Click **Path** and select the save path is Internal or External.
17. Click **Name** Numeric Display Box and set the value require.

**To select the FFT window**

■ There are 6 FFT windows. Each one has trade-offs between frequency resolution and amplitude accuracy. What you want to measure and your source signal characteristics help you to determine which window to use. Use the following guidelines to select the best window.

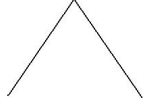
Type	Characteristics	Window
Rectangle	<p>Best solution for frequency, worst for amplitude.</p> <p>Best type for measuring the frequency spectrum of nonrepetitive signals and measuring frequency components near DC.</p> <p>Recommend to use for:</p> <ul style="list-style-type: none"> <li>● Transients or bursts, the signal level before and after the event are nearly equal.</li> <li>● Equal-amplitude sine waves with frequencies those are very close.</li> </ul> <p>Broadband random noise with a relatively slow varying spectrum.</p>	
Hanning	<p>Good for amplitude, but poorer frequency resolution than Hamming.</p> <p>Recommend to use for:</p> <ul style="list-style-type: none"> <li>● Sine, periodic and narrow band random noise.</li> <li>● Transients or bursts where the signal levels before and after the event are significantly different.</li> </ul>	

Hamming	<p>Better solution for amplitude than Rectangle, and good for frequency as well. It has slightly better frequency resolution than Hanning.</p> <p>Recommend to use for:</p> <ul style="list-style-type: none"> <li>● Sine, periodic and narrow band random noise.</li> <li>● Transients or bursts where the signal levels before and after the event are significantly different.</li> </ul>	
Blackman	<p>Best solution for amplitude, worst for frequency.</p> <p>Recommend to use for:</p> <ul style="list-style-type: none"> <li>● Single frequency waveforms, to find higher order harmonics.</li> </ul>	
Bartlett	<p>The Bartlett window is a slightly narrower variant of the triangular window, with zero weight at both ends.</p>	
Kaiser	<p>The frequency resolution when using the Kaiser window is fair; the spectral leakage and amplitude accuracy are both good.</p> <p>The Kaiser window is best used when frequencies are very close to the same value but have widely differing amplitudes (the side lobe level and shape factor are closest to the traditional Gaussian RBW). This window is also good for random signals.</p>	

**Notes for using FFT**

- Use the default **dB** scale for details of multiple frequencies, even if they have very different amplitudes. Use the **dB** scale to compare frequencies.
- DC component or offset can cause incorrect magnitude values of FFT waveform. To minimize the DC component, choose AC Coupling on the source signal.
- To reduce random noise and aliased components in repetitive or single-shot events, set the oscilloscope acquisition mode to average.



**What is Nyquist frequency:**

The Nyquist frequency is the highest frequency that any real-time digitizing oscilloscope can acquire without aliasing. This frequency is half of the sample rate. Frequencies above the Nyquist frequency will be under sampled, which causes aliasing. So pay more attention to the relation between the frequency being sampled and measured.

## How to conduct DIR settings (digital filtering)

Digital filtering supports low pass, high pass, band pass and band reject types, and the specific frequency in the signal can be filtered out by setting the cut-off frequency. The setting window is shown as below:



1. Click DIR in the analytical module from the main menu window  at the lower right of the screen.
2. Click **Switch** at the DIR Menu Setting Window displayed on the screen; when the switch label is highlighted on the right, it is enabled. The pink waveform M will be displayed on the screen.
3. Select CH1 or CH2 in the **Information Source** menu.
4. Select the filter required in the **Type** menu.
5. Select the appropriate window in the **Window** menu.
6. Click **Cut-off Frequency** numeric window  
 When **Low Pass** or **High Pass** is selected as the filter type, it is available to set the required cut-off frequency in the lower part of the menu.  
 When **Band Pass** or **Band Reject** is selected as the filter type, it is available to set the required **Upper Frequency Limit** or **Lower Frequency Limit** in the lower part of the menu.
7. Click Vertical Position in the menu, directly click Numeric Input Box to input the vertical position of the Math Waveform to be set and click the unit to confirm; or click Gear Input Box (- or +) or turn General knob to set the vertical position of the Math Waveform to be set, click < > or press 

 to move the cursor and select the digit to be set. The voltage gear of

the Math Waveform is the same as that of the current channel.

**Note: In slow sweep, the digital filter function is disabled.**

## How to conduct frequency response analysis

The Frequency Response Analysis (FRA) function controls the built-in signal generator to scan the sine waves across the frequency range and simultaneously measure the input and output of the device under test. The gains and phases are measured at each frequency and plotted on the frequency response Bode Plot. After the frequency response analysis is completed, you can move the marker on the graph to see the gain and phase values measured at various frequency points. You can also adjust the scale and offset settings of gain and phase graphs.

Note: If the signal is interfered seriously, it is recommended to set the average value acquisition as the collection mode before operating the frequency response analysis. The average frequency can only be selected to 4 or 16, and then the frequency response analysis can be performed.

Click FRA in the analytical module from the main menu window  at the lower right of the screen.

The descriptions of the menu are shown below:

Menu	Descriptions
Switch	Enable FRA function. When it is enabled, the FRA scale and Bode Plot are displayed on the screen.
Start Analysis	Operate the frequency response analysis. Information displayed during the frequency sweep process: Frequency, Gain and Phase.
Points/Decade	Points displayed every 10x frequency, ranging from 10 to 100 with the default value of 10.
Start Freq	Set the start value of sweep frequency, ranging from 10Hz to 25MHz with the default value of 10Hz.
End Freq	Set the stop value of sweep frequency, ranging from 10Hz to 25MHz with the default value of 25MHz. Note: The value of “End Frequency” shall be set larger than that of “Start Frequency”.
Amplitude	Set the voltage amplitudes for different frequency ranges. Note: The amplitude ranges from 2mV to 6V.
Move Maker	Move the sign to view the measured gain and phase values.
Gain Scale	Adjust the gain scale value of the amplitude-frequency curve, ranging from 5.0dB/div to 50.0dB/div.

## 5. Use the Oscilloscope

Gain Offset	Adjust the offset position of the amplitude-frequency curve, ranging from -250.0dB to 250.0dB.
Phase Scale	Adjust the phase scale value of the phase-frequency curve, ranging from 5.0°/div to 90.0°/div.
Phase Offset	Adjust the offset position of the phase-frequency curve, ranging from -180.0° to 180.0°.
Auto Scale	Automatically set the gain scale and phase scale to the appropriate values based on the amplitude-frequency curve generated, so that the waveform is occupying the largest plot area and easy to be observed.
CSV Export	The saved file is exported as *.csv.
Connection Diagram	Before using FRA function, it is required to make proper loop connection. Click <b>Wiring Diagram</b> to view the circuit wiring diagram with FRA function in the pop-up window; click any location outside the pop-up window to close the wiring diagram window.

To run the frequency response analysis, operate according to the following steps:

1. Connect the output end of the built-in signal generator to the device under test and connect input channel CH1 and CH2 of the oscilloscope to the input and output end of the device respectively.
2. Click FRA in the analytical module from the main menu window  at the lower right of the screen.
3. Click **Switch** in the **FRA** Menu Setting window displayed on the screen; when the switch label is highlighted on the right, it is enabled.
4. Click the menu in the **FRA** Menu Setting window and set related parameters.
5. Click "**Start Analyze**" in the FRA Menu Setting window to run the frequency response analysis.

## 5. Use the Oscilloscope

### Under FRA Analysis

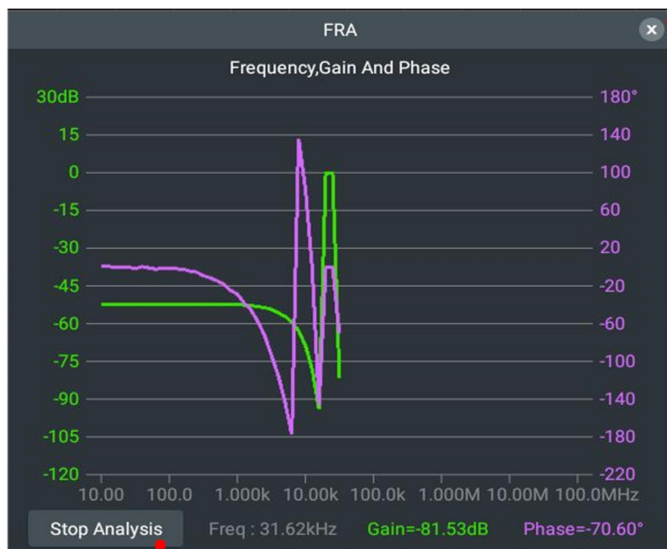

Click to close the window

Click to stop FRA analysis

### End of FRA Analysis



Click to close the window

Turn the knob to move the symbol

### How to pass the test setting

Menu	Setting	Descriptions
Switch		Open or close Pass/Fail measure function.
Operate		Control operate switch.

5. Use the Oscilloscope

<b>Configuration</b>	<b>Source</b>	<b>CH1</b>	Select CH1 or CH2 source.
		<b>CH2</b>	
	<b>Category</b>	<b>PASS</b> <b>FAIL</b>	Select pass or fail set type. Pass:The measured signal conforms to the set rules; Fail:The measured signal doesn't conforms to the set rules.
	<b>OutputStopped</b>	Open or close OutputStopped function. When enabled, it stops as soon as the set rules are met.	
	<b>Bell</b>	Open or close Bell function. When enabled, the bell rings when the setting is met.	
	<b>Message Display</b>	Open or close pass/fail message display navigate window.	
<b>TheMaskRule</b>	<b>Horizontally Disposed</b>	Click Numeric Input Box, set the horizontal value required.	
	<b>Vertically Disposed</b>	Click Numeric Input Box, set the vertical value required.	
	<b>CreateRule</b>	Click to set the conditions as the test rules.	
<b>Mask save &amp; read</b>	<b>0 Null</b> ... <b>7 Null</b>	According to require test rule, can set 8 groups test rules. Note: Null: Indicates empty, no rule is created; Rule: Indicates that a rule has been created.	
	<b>Save</b>	Click and save the set test rules.	
	<b>Rename</b>	According to requirement to rename the rule.	
	<b>Output</b>	Click to print the saved test rule.	

**Pass/Fail:** It detects whether the input signal of the channel is within the rules. If it is out of range, it is a failure; otherwise, it is a pass. It can output failure or pass signal through the built-in, configurable output port.

To perform a Pass/Fail test, follow these steps:

1. Click **Pass Fail** in the analysis module in the main menu window at the



bottom right of the screen .

2. In the screen display pass test menu Settings window, when the switch label is highlighted on the right, it is enabled.
3. **Configuration:**In the configuration menu, set output type is **Pass** or **Fail**; set output mode whether to open **Output Stopped** or **Bell**; set whether to open message **Display Information** .
4. **TheMaskRule:**In TheMaskRule menu select **Source**, in **Horizontal Disposed** or **Vertical Disposed** , click Numeric Input Box , set horizontal value or vertical value; click to **Create rule**.
5. **Operate:**Click **Operate**, when the switch label is highlighted on the right, it is enabled.
6. **Mask save & Read:**Select **Save** in the bottom of the screen, you can call the **Output** immediately when you need it later. You can also click Output in the menu to output the saved rules.

**Note:**

1. In the case of Pass/Fail on, open XY mode or FFT, Pass/Fail will close; In XY or FFT mode, Pass/Fail function menu is gray, it can not to use;
2. In factory setting, automatic range, Pass/Fail will close;
3. During the detection process, the signal source cannot be modified, and the output stop, ring, create rule, save, and read operations cannot be performed. Only the information display and switch operations can be performed;
4. In stop state, don't compare data. While continuing to run, pass fail total will add it, doesn't start at 0.

**Other function modules include: Display, XY Mode, Save, Reference Waveform, Self-calibration, Probe Check and Wave Clone.**

For the settings of display function parameters, refer to “How to set display system ” in Page 74.

For the settings of XY mode function parameters, refer to “How to set XY mode” in Page 76.

For the settings of save function parameters, refer to “How to save” in Page 77 .

For the settings of self-calibration function parameters, refer to “How to conduct self-calibration ” in Page 14.



## How to conduct reference waveform setting

100 reference waveforms can be stored in the instrument, which can be displayed with current waveform simultaneously. The stored waveform can not be adjusted after being called.

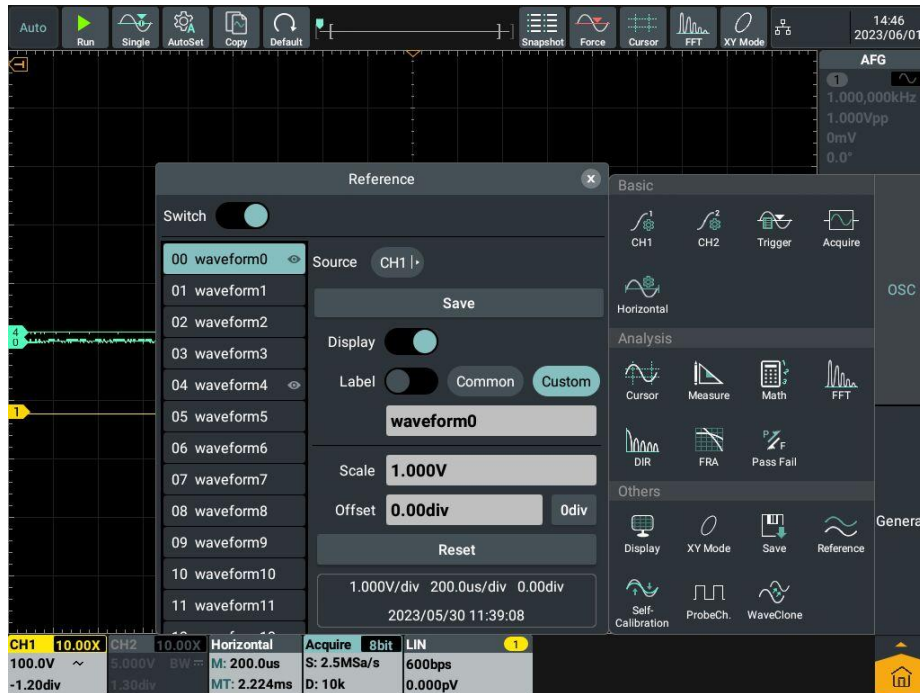
The setting interface of the reference waveform is shown as follows



To store CH1 channel waveform to waveform0, operate according to the following steps:

1. Open CH1 channel.
2. Click **Reference** in other modules from the main menu window  at the lower right of the screen.
3. Click **Switch** in the Reference Waveform Menu Setting window displayed on the screen; when the switch label is highlighted on the right, it is enabled.
4. Click 00 waveform0 from the reference waveform list.
5. Click **CH1** in the **Signal Source** menu to highlight it.
6. Click **Save** softkey in the menu and the waveform is saved in the internal memory of the oscilloscope. It is available to customize the waveform name or save it as the waveform0 by default.
7. When the switch label is highlighted on the right, it is enabled. There is a  label behind the name of reference waveform selected from the reference waveform list, the selected reference waveform is displayed on the screen and the waveform name and relevant information are displayed at the lower right corner of the reference waveform Information Box.  
When the display switch is closed, the  label disappears and the reference waveform displayed on the screen will be hidden accordingly.
8. Click the soft key of a label in the menu to select a common type or a Custom type. When you select a common type, you can select 31 types of labels. When you select a Custom type, you can click the

input box below to enter the required labels. This function is synchronized to rename the reference waveform name.

9. Click on the value input box of the voltage gear to set the desired value of the stored waveform voltage.
10. Click on the value input box for vertical position to set the desired vertical position of the memory waveform, click **0div** can quickly return zero.
11. Click the **Reset** softkey to reset the voltage gear and vertical position of the reference waveform to the gear and position displayed in the information box.
12. **Reference Waveform information box:** Displays the selected reference waveform.

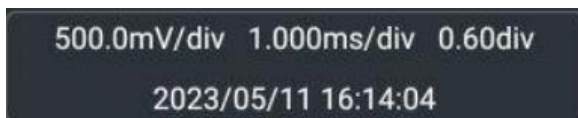

Note: The reference waveform can currently save the waveform in CH1, CH2, Math, FFT mode.

## How to conduct probe check

Click **Probe Check** in other modules from the main menu window  at the lower right of the screen, and the "Probe Check" prompt box will pop up on the screen.

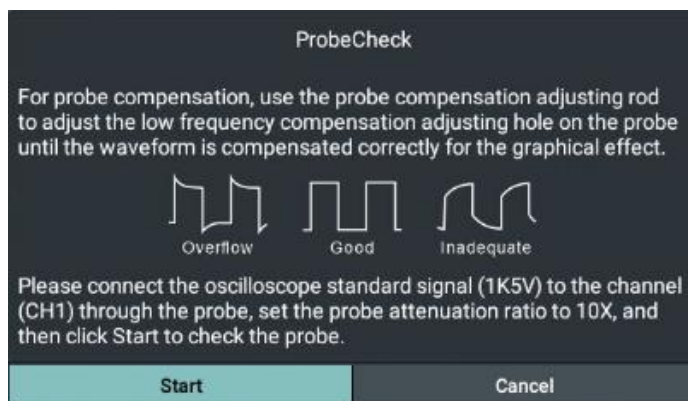

Click **Start** to perform the probe check.

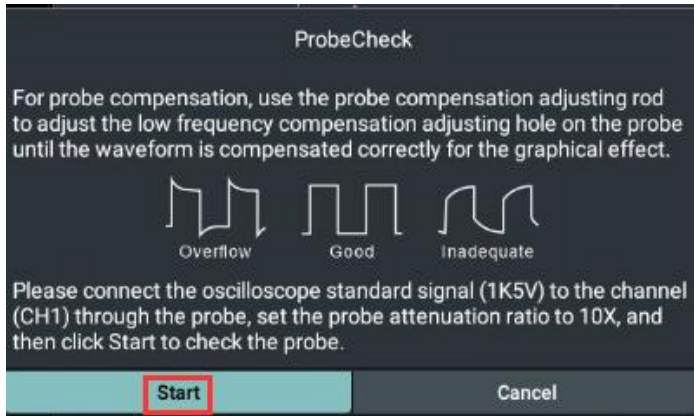

After completing the probe check, the check results are displayed on the screen and click **Exit**. If the result is **undercompensation** or **overcompensation**, please refer to “How to conduct probe compensation” on Page 12 for specific operations.



## How to clone and restore waveform

Click **Waveform Clone** in other modules from the main menu window  on the lower right of the screen.

The waveform clone function can clone the waveform of one channel or two channels within the time cursor range on the screen, as a group of cloned waveform and saved to the internal storage or directly cloned to the signal generator, as the output waveform of the signal generator. A total of 4 cloned waveforms can be saved in the internal memory of the instrument.

The descriptions of Waveform Clone Menu are shown in the table below:

Menu	Setting	Descriptions
Switch		Enable/disable the waveform clone function.

5. Use the Oscilloscope

Line	<p>X1 X2 X1&amp;X2 Full Screen</p>	<p>Turn <b>General</b> knob to move X1 cursor line Turn <b>General</b> knob to move X2 cursor line Lock the distance between X1 and X2 and turn <b>General</b> knob to move two cursor lines simultaneously The information of the selected waveform is displayed at the lower left corner of the screen.</p> <div style="text-align: center;"> <p>Length                  Time                  Frequency</p>  </div> <p>Note: If “<b>Out of Limits</b>” appears in the message or “<b>Waveform Points Exceed the Limit</b>” is displayed on the screen, it indicates that the selected range exceeds the point limit. Press <b>Acquire</b> key to select the Record Length in the menu below and set it to a smaller value.</p>
Wave Output	<p>OSC      AFG CH1 CH2 —&gt; CH1 NULL CH1 CH2 —&gt; CH2 NULL  Clone</p>	<p>Select the signal source mode. The signal source is the waveform of a channel, which is used to output the signal generator <b>CH1</b>. In the right CH1 menu, you can specify the waveform to be cloned. The signal source is the waveform of a channel, which is used to output the signal generator CH2. In the right <b>CH2</b> menu, you can specify the waveform to be cloned. The signal source is the waveform of two channels, which is used to output the signal generator CH1 and CH2. You can specify the waveform to be cloned in the signal source <b>CH1</b> and <b>CH2</b> menu. Clone the waveform selected by the cursor line on the screen and output it directly from the local AG signal source.</p>
Save& Output	<p>0 waveform0 1 waveform1 2 waveform2 3 waveform3</p>	<p>Target waveform memory (waveform0 - waveform3, you can customize the name).</p>
	<p>Save</p>	<p>Save the waveform selected by the cursor line on the screen to one of the four target waveforms in the internal memory; when a target is selected from the left target waveform list, the information of such target will be displayed at the bottom of the cloned waveform, showing if the current target has a waveform and the signal source mode of the waveform.</p>
	<p>Rename</p> <p>Output</p>	<p>Rename the target waveform as required.</p> <p>Output the waveform saved in the selected target on the left.</p>

### How to quickly output the cloned waveform selected by the cursor line

- (1) Click **Wave Clone** in other modules from the main menu window  on the lower right of the screen.
- (2) Click **Switch** to enable it.
- (3) Select the cursor line from the **Line** menu and move to select the waveform range.
- (4) Select the signal source to be output **CH1/CH2/NULL** from the **OSC** Menu on the left of the waveform output (Selecting NULL indicates no output from this channel).
- (5) Select the signal source channel **Probe Check** from the right **AFG** menu.
- (6) Click **Clone** in the menu.

For specific operations of the cursor line, refer to “How to conduct cursor measurement” in Page 52.

### Save Cloned Waveform:

- (1) Click **Wave Clone** in other modules from the main menu window  on the lower right of the screen.
- (2) Click **Switch** to enable it.
- (3) Save the target item to be saved in the **Save&Output** target menu.
- (4) Click **Save** in the menu or click **Rename** as required, then input a new target name on the input soft keyboard and click **Save**. The target will be displayed in the target menu with the new name.

### Output Cloned Waveform:

- (1) Click **Wave Clone** in other modules from the main menu window  on the lower right of the screen.
- (2) Click **Switch** to enable it.
- (3) Select the target from the **Save&Output** target menu.
- (4) Click **Output** in the menu.

## General

General module is composed of Network, Default, About, Teaching Model, Configuration and Hardware Detection.

### How to conduct network settings

Conduct the network settings by using **LAN** interface or **Wi-Fi** module. If the **LAN** interface is used, directly insert the network cable into the LAN interface

on the back of the instrument to complete the network connection; if the WiFi module is used to connect the network, insert the external WiFi module, press the **Home** key in the Android system area on the front panel, click Setting to enter the setting interface, then click WLAN switch to enable it, and the network will be connected automatically. If it is the first time to connect to WiFi, click it gain to select the WiFi account, then click the account and enter the WiFi password to connect the network.

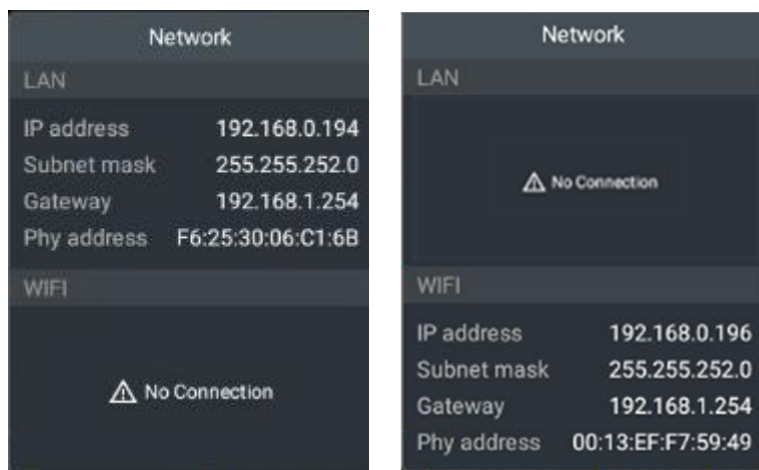

### Default

Restore the factory settings. Click **Default** soft key and click **OK** in the factory settings displayed, to restore the factory default state; Click **Cancel** if it is not needed.

### About

It is composed of About the Application and About the Instrument. The former is to display the latest **version** of the instrument; and the latter is to show the instrument **Product Model**, **Serial Number** and **System Version**.

### Teaching Model

The teaching model is mainly applied to school teaching. Click **Teach Model** and the Password Input Box is displayed on the screen; input the password and click **Go into Teaching Mode** to enter the teaching model. In teaching model, automatic measurement, automatic setting and cursor functions are unavailable. For other functions, refer to the operations of the instrument. Click Teaching Model, input the password and click **Exit Teaching Model**.

### Configuration

Set up other auxiliary system functions in the instrument.

This function is mainly used to set the display format of all values in the instrument and set the input box mode of the signal source & power supply.

### Set SyncOutput

Synchronous output is generally used to synchronize trigger signals or

measurement results with other devices or systems for more accurate and comprehensive measurement, analysis, and control. The output types of the synchronous output of this instrument are trigger output and pass/fail, which can help the user better control and analyze the trigger and validity of the measurement process.

- **Trigger output:** The synchronous output trigger signal, that is, the trigger output in the synchronous output allows the instrument to output its internal trigger signal to other devices to control it to start measuring or recording operations;
- **Pass/Fail:** Detects and determines whether the input signal passes the predefined upper and lower limits.

### Set display format

It is mainly used to set the display format of all the values in the instrument.

- Click **Decimal Symbol** to display the decimal symbol as a **decimal point** or **comma**;
- Click **Thousand Separator** to set a **comma** (decimal point, subject to decimal symbol) or a **space** between thousand separators

Note: If the symbol type is different from the current instrument, a prompt box "Do you want to restart the application to make the configuration effective?" will be popped up. Click **OK** to restart the application to make the configuration effective.

### Set Input Box Mode

In the signal source or power parameter setting mode, you can set the input mode to Step Input or Keypad.

- In Step Input mode, click the Parameter Input Box to pop up the step input mode, click + or – to increase or reduce the value at the cursor, and click < > to move the cursor position of the value. In Step Input mode, double click the Parameter Input Box to switch to Keypad Input Mode.
- In Keypad Input mode, input the value on the keypad as required, select the unit of the parameter and confirm the value input.

### Foundation setting

**Window time:** Set window display time, the value can be set Close、 5s、 10s、 15s、 20s、 25s、 30s. When the set time is up, the pop-up window will automatically close.

**Beeper:** Click to open or close Beeper voice. After opening, there will be sound prompts for still and click operations or panel operations.

**Operating lock:** Click to open or close touch setting and panel operation. After opening, you need to press the Run/Stop button three times to unlock.

### Hardware Detection

The function is mainly for the self-inspection of the instrument, including screen detection and key detection, which is used to detect if there is any



bright spots or bad spots on the screen, and if there is any wrong key, missing key or reversed key on the instrument.

## How to use execution keys

The execution keys include **Auto Setting, Run/Stop, Single and Copy**.

### Automatic Settings:

Set various control values automatically to generate the display waveforms suitable for observation. Press **Auto Set** key and the oscilloscope will quickly detect the signal automatically.

The Function Items for Automatic Settings are shown in the table below:

Function Item	Settings
Vertical Coupling	DC(channel coupling remains closed)
Channel switch	Signal open or close (channel switch remains closed)
Vertical Gear	Adjust to the proper gear
Channel Bandwidth	Current
Horizontal Displacement	Center or two squares to left or right
Horizontal Gear	Adjust to the proper gear
Trigger Type	Edge
Trigger Signal Source	CH1 or CH2
Trigger Coupling	DC
Trigger Slope	Current
Trigger Level	At 50% of waveform
Trigger Mode	Auto
Display Mode	YT
Math	Off
FFT	Off
Waveform Amplification	Exit
Pass test	Off

### Autoset judge waveforms type

There are four types: Sine wave or Ramp wave, Square wave or Pulse wave, DC level, unknown source.

The waveform type prompt is displayed on the screen, and the corresponding bottom menu is displayed.

#### Menu display:

Sine wave: signal period, multi periods, cancel autoset, auxiliary menu set.

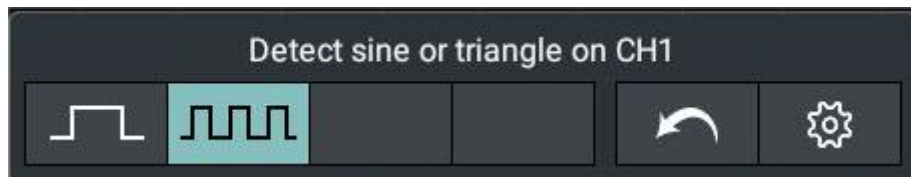

Square wave or Pulse wave: signal period, multi periods, rising edge, falling edge, cancel autoset, auxiliary menu set.

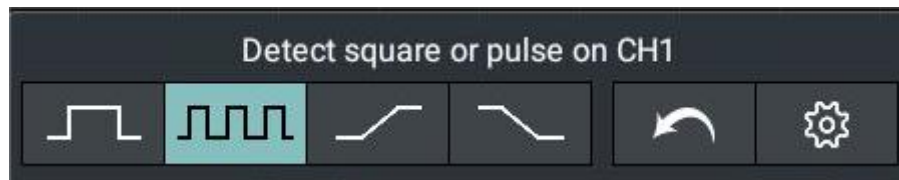

DC level: cancel autoset, auxiliary menu set.

Unknown source: cancel autoset, auxiliary menu set.



**Partial description of nouns:**

Signal period: Display 1~2 waveform periods.

Multi periods: Display multiple waveform periods.

Rising edge: Separate shows a rising edge of square wave.

Falling edge: Separate shows a falling edge of square wave.

Cancel autoset: Returns information about the last menu and signal.

**Auxiliary menu set:** Click to enter the auxiliary menu system, including channel switch hold and channel coupling hold.

- Channel switch hold: Select open or close channel switch hold function. If open channel switch hold, perform autoset will detect two analog channels CH1 or CH2. If doesn't detect channel source, it will close the channel; if detect channel source, it will adjust the best gear to display. If open channel switch hold, no signal channels are closed and perform autoset operation only detect opening channel.
- Channel coupling hold: Select open or close channel coupling hold function. If open channel coupling hold function, perform autoset operation, channel coupling setting remain unchanged; if close channel coupling hold function, channel coupling default is DC coupling.



**Note:** If the automatic waveform setting is applied, the frequency and amplitude of the measured signal shall not be less than 20Hz and 5mv, respectively. If the condition is not met, the automatic waveform setting may be invalid.

**Run/Stop:** Run and Stop the waveform acquisition.

Note: In the stop state, the vertical gear and horizontal time base of the waveform can be adjusted within a certain range, equivalent to extend the signal in the horizontal or vertical direction. When the horizontal time base is 50ms or less, the horizontal time base can be extended down to 4 gears.

**Single:** Press this key to directly set the trigger mode as single, which is to acquire a waveform when one trigger is detected and then stop acquisition.

**Copy:** Press **Copy** panel on any interface directly to save the signal source waveform. The signal source and the storage location depend on the settings of **Waveform** Type in the **Save** function menu. For details, see "Save Function Menu" in Page 58.

## 6.Use Arbitrary Waveform/Function Generator

### Arbitrary waveform/function generator area of front panel

Signal Source Display window, click to display /

hide the signal source setting window

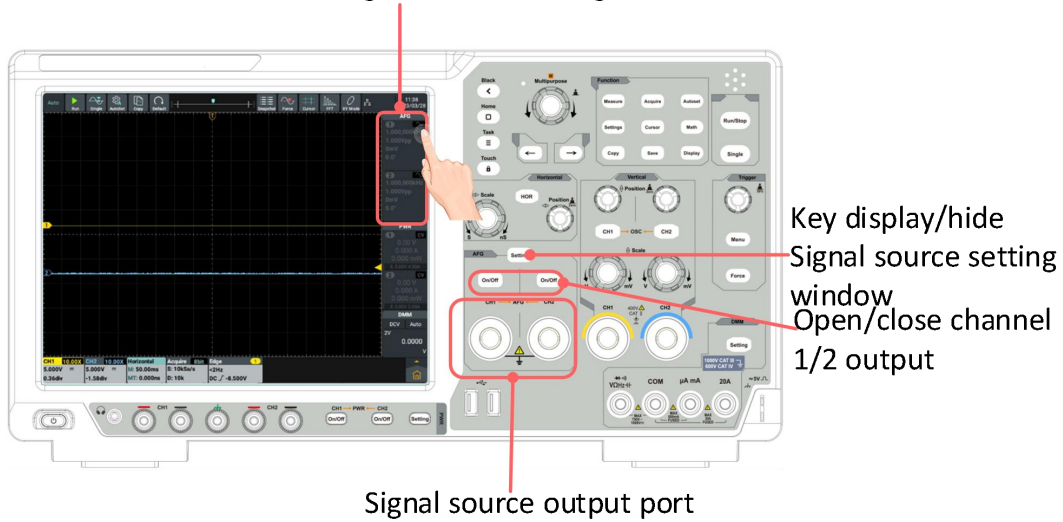

### Display window of arbitrary waveform/function generator

The display window of arbitrary waveform/function generator is located at the upper right of the screen. Refer to Channel 1 for the descriptions of Channel 2.



Figure A

Figure B

#### Descriptions:

1. Display the channel name and the channel output switch status.

2. Display the frequency/cycle.
3. Display the amplitude/high level.
4. Display the offset/low level.
5. Initial phase .
6. Figure A: Display the pulsewidth/duty ratio.
7. Figure A: Display the current waveform.
8. Figure B: Display the current modulation mode.

## Setting Window of arbitrary waveform/function generator

The display window of arbitrary waveform/function generator is located at the upper right of the screen. Refer to Channel 1 for the descriptions of Channel 2.

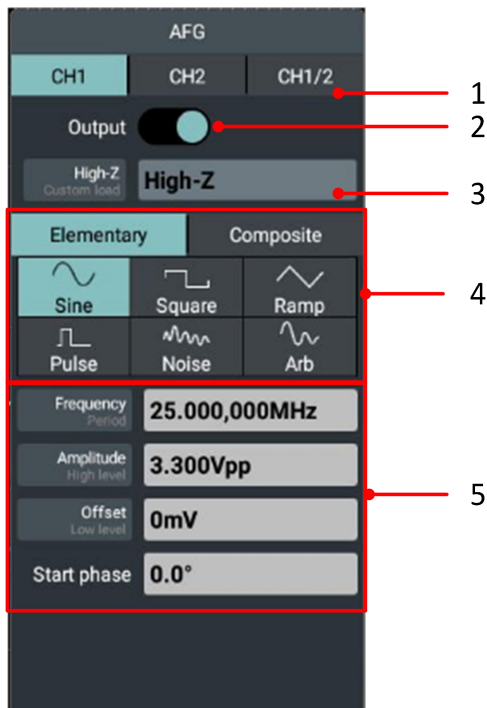

Descriptions:

1. Select the channel.
2. Enable or disable the channel output.
3. Select the load: **high resistance** or **Custom load(Range is a to 10k $\Omega$ ,default is 50 $\Omega$ ).**
4. Waveform selection area.
5. Output parameter setting area.

## Connect the output end

Connect BNC cable to the output end of **Channel 1** or **Channel 2** signal

generator of the oscilloscope's front panel.

Press the **On/Off** keys of two channels. To view the output of the signal generator, connect the other end of BNC cable to the signal input channel of the oscilloscope's front panel.

## Set the channel

- **How to switch the channels displayed in the menu**

Open the signal source setting window and click CH1, CH2 or CH1/2 at the upper of the window to switch among **Channel 1** menu, **Channel 2** menu and **Channel Copy** menu.

- **How to enable/disable the channel output**

Press **On/Off** key of two channels to enable/disable the output of corresponding channel. The key light of corresponding channel turns on when the output is enabled.

- **Channel copy menu**

Press **CH1/CH2** softkey to switch to the Channel Copy menu.

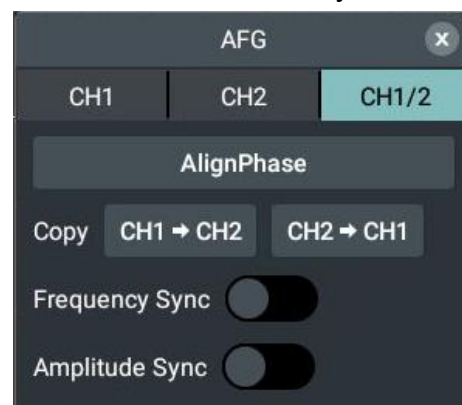

### Align Phase

Click **Align Phase** softkey in the menu below to align the initial phases of two channel signals.

### Copy channel

Select From **CH2→CH1** in the menu below to copy the parameters of Channel 2 to Channel 1.

Select From **CH1→CH2** in the menu below to copy the parameters of Channel 1 to Channel 2.

### Frequency synchronization

Select **Frequency Sync** as **On** in the menu below. When adjusting the frequency of one channel, that of the other changes simultaneously.

### Amplitude synchronization

Select **Amplitude Sync** as **On** in the menu below. When adjusting the amplitude of one channel, that of the other changes simultaneously.

## Set the waveform

- (1) Click **CH 1** or **CH 2** display window to display the setting window of the signal generator.
- (2) Select the waveform required and corresponding waveform setting menu from the menu items at the lower part of the window.
- (3) Operate the setting menu to set the parameters of the waveform required.

Example: Press **Frequency** in the menu below (if there is only **Period** other than **Frequency**, click the title to switch it to **Frequency**), and set the required value, the specific methods are as follows.

**There are 3 methods to change the parameter values selected:**

- **Use digital soft keyboard input mode:** Click **Numeric Display Box** and the soft keyboard appears, and input the required value directly.

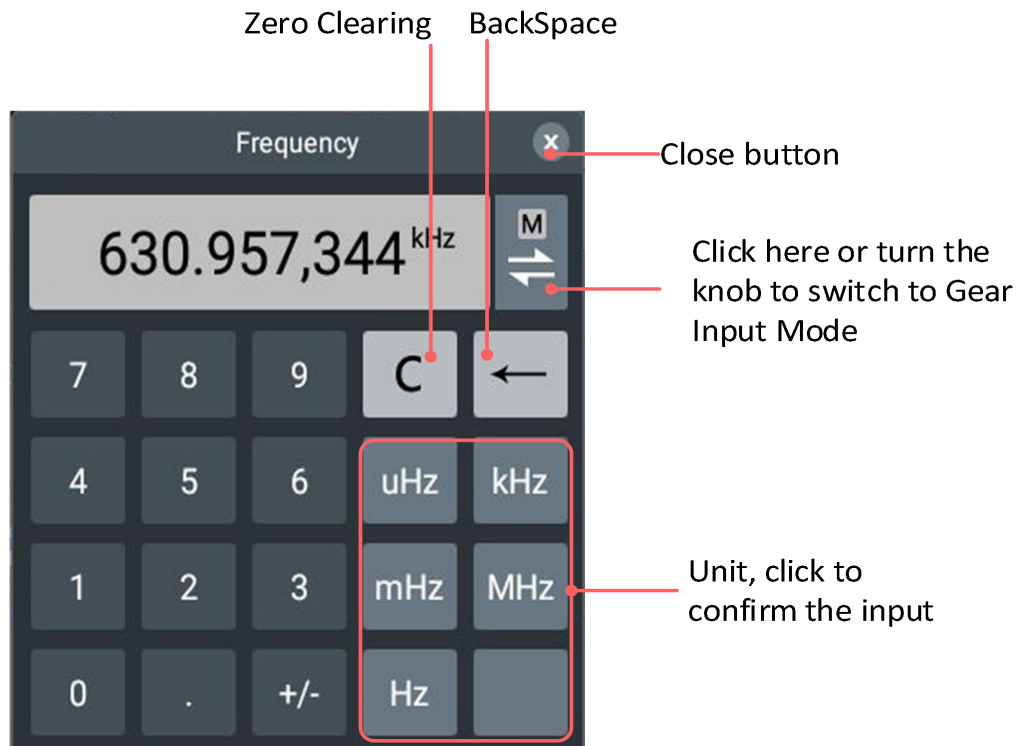

- **Use gear input mode:**

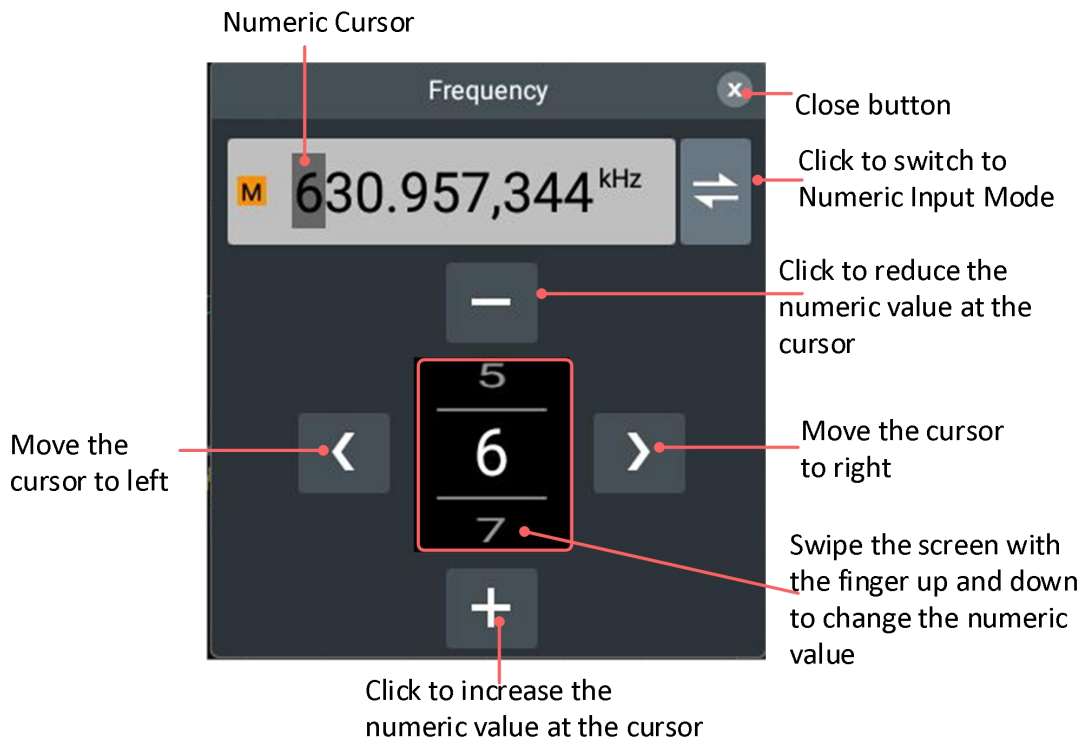

- **Use General Knob:** Turn **General Knob** to increase or decrease the value at the cursor. Press / to move the cursor left and right, see the gear input mode diagram for details.

Parameters that can be set for each waveform

Name	Menu Items
Sine	Frequency/Period, Amplitude/High level, Offset/Low level, Start phase
Square	Frequency/Period, Amplitude/High level, Offset/Low level, Start phase
Ramp	Frequency/Period, Amplitude/High level, Offset/Low level, Start phase, Symmetry
Pulse	Frequency/Period, Amplitude/High level, Offset/Low level, Start phase, PulseWidth/Duty cycle
Noise	Amplitude/High level, Offset/Low level
Arbitrary	Frequency/Period, Amplitude/High level, Offset/Low level, Start phase, Built-in/External

**Taking CH1 output sine wave as an example, the setting steps are as follows**

Click **Settings** key or click the signal source display window at the right side of the screen to display the signal source setting window at the right side of the screen, as shown in the figure below:



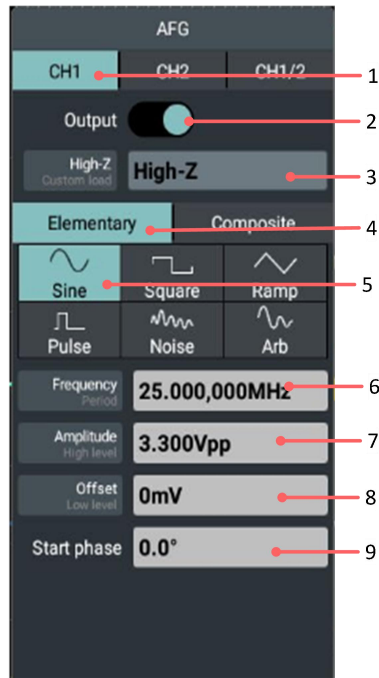

1. Click **CH1** at the setting window.
2. Click **Output** to highlight the switch.
3. Click **High Z/Custom Load** to set the required load mode, and the custom load ranges from 1Ω to 10kΩ.
4. Select **Elementary**.
5. Select **Sine** for the waveform type.
6. Set **Frequency/Period**; when the frequency font is white and the cycle font is gray, the frequency value can be set; when the frequency font is gray and the cycle font is white, the cycle value can be set. Click Frequency/Cycle to switch between the frequency and the cycle.
7. Set **Amplitude/High Level**; when the amplitude font is white and the high level font is gray, the amplitude value can be set; when the amplitude font is gray and the high level font is white, the high level value can be set. Click Amplitude/High level to switch between the amplitude and the high level.
8. Set **Offset/Low Level**; when the offset font is white and the low level font is gray, the offset value can be set; when the offset font is gray and the low level font is white, the low level value can be set. Click **Offset/Low Level** to switch between the offset and the low level.
9. Set **Start Phase**; click Numeric Display Box to set the phase parameters in the setting box. For specific setting mode, refer to “Three Methods to Change the Selected Parameter Value”.

**Note:** For the parameter settings of square wave, ramp wave, pulse wave and noise wave, refer to the operations mentioned above.

## Output Built-in Waveform

There are 28 kinds of built-in waveforms. To select the built-in waveform, follow the steps below:

- (1) Click **CH 1** or **CH 2** display window to display the setting window of the signal generator.
- (2) Select **Arbitrary Wave** in the menu below and click **Built-in External**.
- (3) Select the classification of the built-in wave in the menu: **Engineering**, **Maths**, **Medical**, **Trigonometric** or **Others**. For example, select **Others**.
- (4) Click **DC** to output the DC voltage waveform.

### Built-in Waveform Table

Name	Explanation
<b>Engineering</b>	
Butterworth	Butterworth filter
Combin	Combined function
CPulse	C-Pulse signal
RoundsHalf	Half-round wave
BandLimited	Band limited signal
BlaseiWave	Blasting vibration "time-vibration speed" curve
Chebyshev1	Type I Chebyshev filter
Chebyshev2	Type II Chebyshev filter
DampedOsc	Damped oscillation "time-displacement" curve
DualTone	Dual audio signal
<b>Maths</b>	
Besselj	Type I Bessel function
Bessely	Type II Bessel function
Log	Base 10 logarithmic function
X^2	Square function
X^3	Cubic function
<b>Medical</b>	
LFPulse	Low frequency pulse electrotherapy waveform
Tens1	Neuroelectric stimulation therapy waveform 1
EOG	Electrooculogram
<b>Trigonometric</b>	
Cosh	Hyperbolic cosine
Cot	Cotangent function

CotH	Hyperbolic cotangent
CotHCon	Concave hyperbolic cotangent
Csc	Cosecant
CscCon	Recessed cosecant
CscPro	Raised cosecant
Csch	Hyperbolic cosecant
CochCon	Depressed hyperbolic cosecant
<b>Others</b>	
DC	DC signal

## Output Modulation Waveform

Supported modulation types include: Amplitude Modulation (AM), Frequency Modulation (FM), Phase Modulation (PM) and Frequency-shift Keying (FSK).

Press **Setting** key in the signal source area of the panel or directly click the signal source display window at the right side of the screen to pop up the signal source setting window, click **Composite** and select **Modulation**; click **Type** menu to select the modulation type. To disable the modulation, pop up the signal source setting window again, select **Continue** in the **Composite**.

Parameters that can be set for various modulation types.

Type	Settings
AM	Mod.Wave、 Mod.Freq、 Mod.Depth
FM	Mod.Wave、 Mod.Freq、 Frequency deviation
PM	Mod.Wave、 Mod.Freq、 Phase.Dev
FSK	Mod.Freq、 Hop Freq

**Taking the Amplitude Modulation (AM) parameters as an example, the setting steps are as follows**

1. Press **Settings** function key or directly click the signal source display window at the right side of the screen to pop up the signal source setting window.
2. Select **Composite** and select **Modulation** .
3. Click **Type** menu and select **AM** as the modulation type.
4. Click **Mod.Wave** and select the modulation waveform required, including Sine Wave, Square Wave, Ramp Wave and Noise Wave.
5. Click **Mod.Freq** to set the modulation frequency required. Refer to “Three Methods to Change the Selected Parameter Values” for specific setting mode.
6. Click **Mod.Depth** to set the modulation depth required. Refer to “Three Methods to Change the Selected Parameter Values” for specific setting mode.

For the parameter settings of Frequency Modulation (FM), Phase Modulation (PM) and Frequency-shift Keying (FSK), refer to “Amplitude Modulation (AM)” for details.

## Output Sweep Waveform

In the sweep mode, the output varies from the start frequency to stop frequency within the specific scan time. Only sine wave, square wave, sawtooth wave or arbitrary wave (except DC) can be used to product sweep waveforms.

When the output signal is sine wave, square wave, ramp wave or arbitrary wave, press **Setting** key at the signal source area of the front panel or directly press the signal source display window at the right side of the screen to pop up the signal source setting window, then click **Sweep** in the **Composite** to enter the sweep mode.

### Set sweep time

Click **Sweep Time** to set the sweep time, that is, the seconds required from the start frequency to the stop frequency, ranging from 1ms to 500s.

### Set sweep mode

Click **Sweep Way** to set the sweep mode as **Linear** or **Log**.

When **Linear** is selected, the output frequency varies linearly during the sweep period;

When **Log** is selected, the output frequency varies logarithmically during the sweep period.

### Set the frequency

Click **Start Freq/Ctr Freq** to display “**Start Freq**” in white. Please note that “**Stop Freq**” in **Stop Freq/Freq Span** is also displayed in white; click Numeric Display Box to input the required frequency value.

You can also set the frequency boundary for frequency sweep through the center frequency and frequency range.

$$\text{Center Frequency} = (\text{Start Frequency} + \text{Stop Frequency})/2$$

$$\text{Frequency Range} = \text{Stop Frequency} - \text{Start Frequency}$$

Click **Start Freq/ Ctr Freq** to display “**Ctr Freq**” in white. Please note that “**Freq Span**” in **Stop Freq/ Freq Span** is also displayed in white; click Numeric

Display Box to input the required frequency value.

Note: The Start Frequency and Stop Frequency are the upper limit and lower limit of the sweep frequency. The signal generator always sweeps from the start frequency to the stop frequency and back to the start frequency.

### Set the trigger source

Click **Internal** to use internal signal source;

Click **Manual** to select manual trigger; when the trigger source is switched to Manual, the **Manual Trigger** soft key will be displayed below. Click this soft key to perform a frequency sweep trigger.

To disable **Sweep**, pop up the signal source setting window again, and select **Continuous** in the **Composite**.

### Generate Burst

Press **Setting** function key at the signal source area of the front panel or directly click the signal source display window at the right side of the screen to pop up the signal source setting window, click **Burst** in the **Composite** to generate pulse train waveform output of various waveform functions. The pulse trains can last a specific number of waveform cycles (N cycle pulse trains). Sine wave, square wave, sawtooth wave, pulse wave or arbitrary wave functions can be used (this function is unavailable for noise wave).

In N-cycle mode, Period, N-cycle/Gated and trigger can be set.

To set the N-cycle pulse train parameters under the sine wave, the operating steps are as follows:

Press **Setting** function key at the signal source area of the front panel or directly click the signal source display window at the right side of the screen to pop up the signal source setting window.

1. Click **Burst** in the **Composite**.
2. Click **Period** to set the trigger cycle required.
3. Click **N-cycle/Gated** to display the Number of Cycle in white; then click Numeric Display Box to set the number of cycles required, ranging from 1 to 400,000.
4. Set **Trigger**, click **Internal** to use the internal signal source, the signal generator can only output n-cycle burst, and the burst frequency is determined by the burst cycle. Burst cycles are only available when cycles and internal triggers are highlighted. Press Burst Cycle soft key to set the burst cycle, that is the time from the start of one burst to the start of the next, ranging from 20ns to 500s (minimum value = number of cycles \* cycles).
5. Click **Manual** to select Manual Trigger. When the trigger source is

switched to Manual, the **Manual Trigger** soft key will be displayed below, click this soft key to output a pulse train.

## 7. Use the Power Supply

### Power Supply Area on the Front Panel

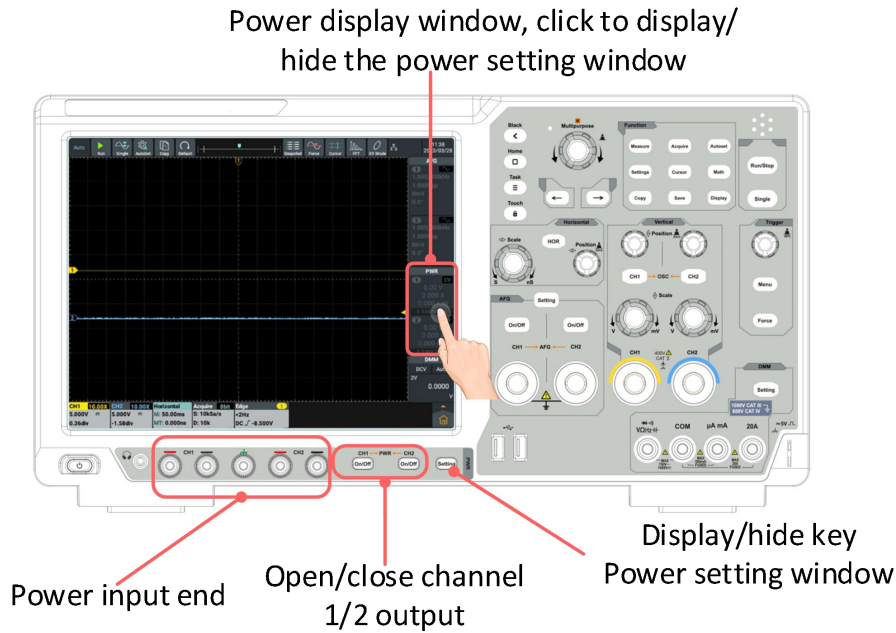

### Power Display Window

The power display window is located in the middle right of the screen. Please refer to Channel 1 for the descriptions of Channel 2.

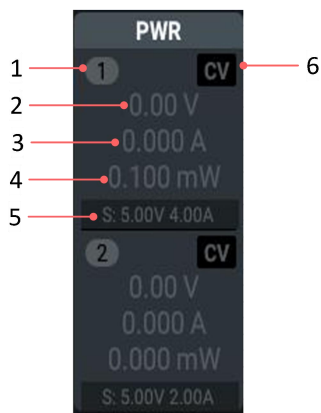

Descriptions:

1. Display channel name and channel output switch status.
2. Actual Output Value of Voltage.

3. Actual Output Value of Current.
4. Actual Output Power.
5. Set Values of Output Voltage/Current.
6. Display Constant Voltage/Constant Current.  
 CV: Constant Voltage Output;  
 CC: Constant Current Output.

## Power Setting Window



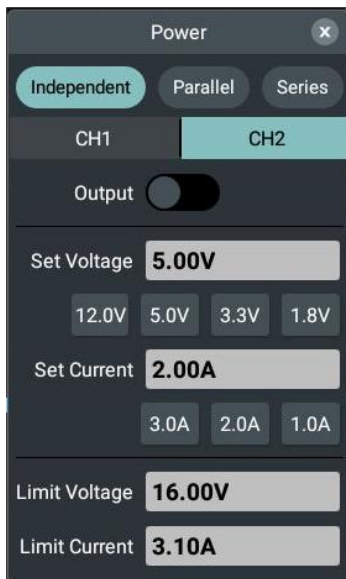



Click Screen Power Display window or press **Setting** key at the power supply area on the screen to display/hide the power measurement setting window.



The descriptions of Power Setting Window setting are shown in the table below:

Menu	Descriptions
Independent Parallel Series	Set current function mode.
CH1 CH2	Setting CH1 channel output parameter; Setting CH2 channel output parameter.
Output	Click to enable/disable voltage output.
Set Voltage	Click "Set Voltage" soft key to pop up the voltage setting box, directly input the voltage value to be set and click the unit to confirm; or directly click Gear Input Box (- or +) or turn <b>General</b> knob to set the voltage value, then click < > or 
12.0V	Quickly set the voltage value, click <b>Confirm</b> to complete the

## 7. Use the Power Supply

5.0V 3.3V 1.8V	voltage value input.
Set Current	Click “Set Current” soft key to pop up the current setting box, directly input the current value to be set and click the unit to confirm; or directly click Gear Input Box (- or +) or turn <b>General</b> knob to set the current value, then click < > or    key to move the cursor and select the digit to be set.
3.0A 2.0A 1.0A	Quickly set the current value, click on the prompt pop-up window <b>Confirm</b> button to complete the current value input.
Limiting Voltage	Click “Limiting Voltage” soft key to pop up the limiting voltage setting box, directly input the limiting voltage value required and click the unit to confirm; or click Gear Input Box (- or +) or turn <b>General</b> knob to set the limiting voltage value, then click < > or   key to move the cursor and select the digit to be set.
Limiting Current	Click “Limiting Current” soft key to pop up the limiting current setting box, directly input the limiting current value required and click the unit to confirm; or click Gear Input Box (- or +) or turn <b>General</b> knob to set the limiting current value, then click < > or   key to move the cursor and select the digit to be set.

## Overvoltage/Overcurrent Protection

After the Overvoltage Protection (O.V.P) or Overcurrent Protection (O.C.P) is enabled, once the output voltage or current reaches the set value of O.V.P or O.C.P, the output of the instrument will be disconnected and the an out-of-limit warning will be displayed on the screen.

### Note:

When the output of the system is disconnected automatically due to protection, the user must close the channel and open it again after proper adjustment before normal output.

This features can protect the power output from exceeding the rated load value.



# 8.Use the Multimeter

## Multimeter Area on the Front Panel

In the Multimeter area on the front panel of the instrument, there is 1 multimeter setting key and 4 multimeter input ends.

The input end of the multimeter is located at the lower right of the front panel, with 4 sockets marked  $\text{V}\Omega\text{Hz}\text{Hzf}$ , COM,  $\mu\text{A}$  mA and 20A, respectively.

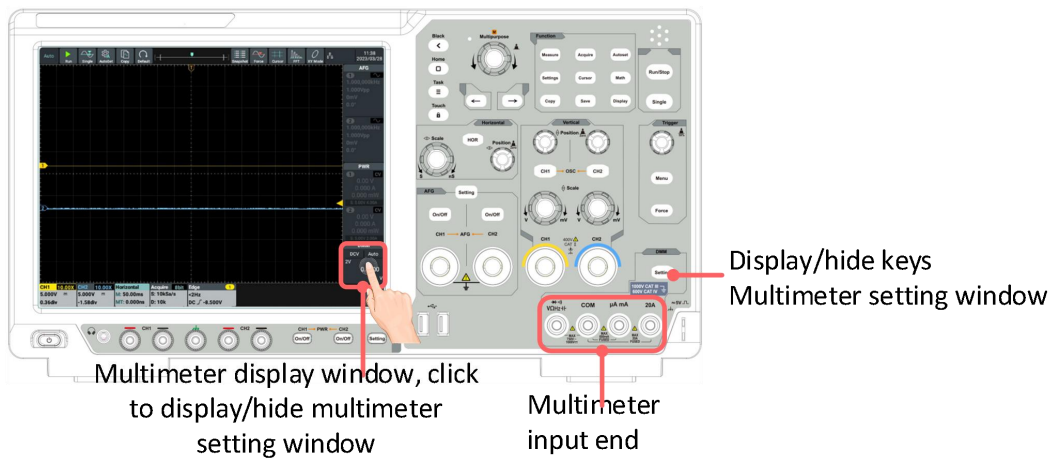

Figure 8- 1: Multimeter Area

## Multimeter Zoom Box

The multimeter Zoom Box is located at the lower right of the screen.

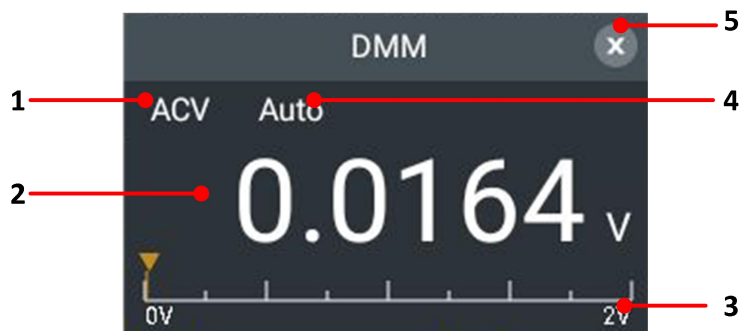

Figure 8- 2: Multimeter Zoom Box

Descriptions:

1. Measuring type indication:

**ACV** ---- AC Voltage Measurement

<b>DCV</b>	----	DC Voltage Measurement
<b>ACI</b>	----	AC Current Measurement
<b>DCI</b>	----	DC Current Measurement
<b>±H</b>	----	Capacitance Measurement
<b>Ω</b>	----	Resistance Measurement
<b>🔊</b>	----	On-off Measurement
<b>⚡</b>	----	Diode Measurement

2. Measured display value; if the measured value is out of range, “**OL**” is displayed.
3. Current Range.
4. Manual Range/Automatic Range Indication: **Manual** indicates manual range; **Auto** indicates automatic range.
5. Zoom Frame Off key.

## Multimeter Setting Window

Click Multimeter display window on the screen or press **Setting** key at the multimeter area of the front panel to display/hide the multimeter measurement setting window.

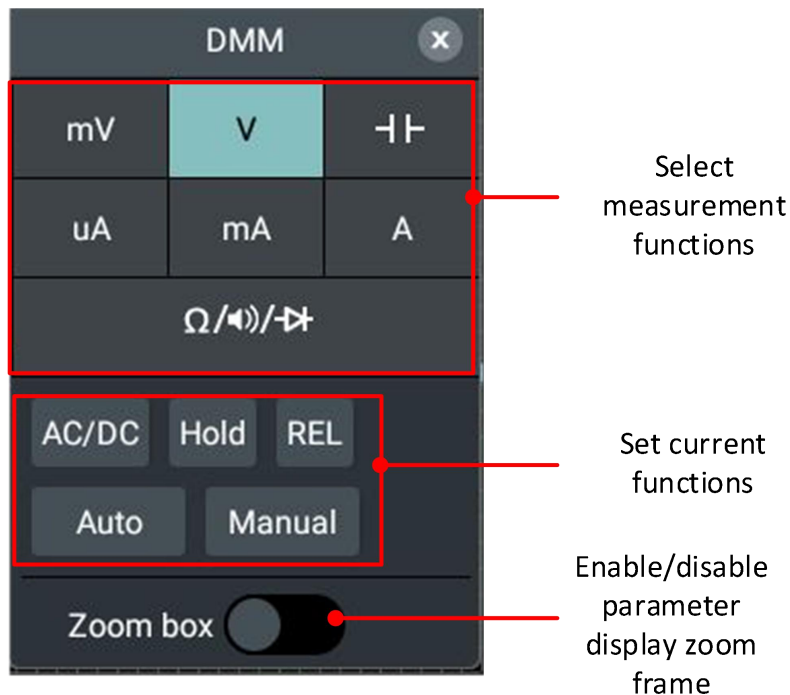

Figure 8- 3:Multimeter setting Window

	Soft Key	Descriptions
<b>Function</b>	mV, V	Measure the voltage.
	$\text{--}\text{  }\text{--}$	Measure the capacitance.
	$\mu\text{A}$ , mA, A	Measure the current.
	$\Omega$ / $\text{--}\text{  }\text{--}$ / $\text{--}\text{  }\text{--}$	Measure the resistance/on-off testing/measure the diode.
<b>Settings</b>	AC/DC	Switch AC/DC upon voltage or current measurement.
	Hold	Keep the current reading on the display.
	REL	Reading is the difference between the stored reference value and the input signal.
	Auto	Select auto range mode.
	Manual	Select manual range mode and press to switch the range.
<b>Zoom box</b>		Open/Close the parameter display zoom box.

## Measure with Multimeter

### Measure AC or DC Voltage

- (1) Click the Multimeter display window on the screen or press **Setting** key at the multimeter area of the front panel to display the multimeter setting window. Click to select **mV** or **V**.
- (2) Click **AC/DC** below to select AC or DC. When **ACV** is displayed at the multimeter display window, it indicates AC voltage is selected; when **DCV** is displayed, it indicates DC voltage is selected.
- (3) Connect the black test pen to the **COM** end of the front panel and the red test pen to the input end of  $\text{V}\Omega\text{Hz}\text{--}\text{||}\text{--}$ .
- (4) Connect the other end of the red test pen and the black test pen to the points to be tested respectively and read the display values.

### Measure AC or DC Current

To measure the AC or DC current less than **200mA**, perform the following steps:

- (1) Click the Multimeter display window on the screen or press **Setting** key at the multimeter area of the front panel to display the Multimeter setting window. Click to select **uA** or **mA**.
- (2) Click **AC/DC** below to select AC and DC. When **ACI** is displayed at the multimeter display window, it indicates AC current is selected; when **DCI** is displayed, it indicates DC current is selected.
- (3) Connect the black test pen to the **COM** end of the front panel and the red test pen to the input end of **uA mA**.
- (4) Turn off the power to the circuit under test. Discharge all high-voltage capacitors on the circuit under test.
- (5) Disconnect the circuit under test. Connect the black test pen to one end of the disconnected circuit (its voltage is relative low) and the red test pen to the other end (its voltage is relative high). If it is connected reversely, the reading will be negative but it will not damage the multimeter.
- (6) Connect the power supply to the circuit and read the measured value.
- (7) Turn off the power supply to the circuit under test. Discharge all high-voltage capacitors. Remove the test pen and restore the circuit to its original state.

To measure AC or DC current between **200mA** and **20A**, perform the following steps:

- (1) Click the Multimeter display window on the screen or press **Setting** key at the multimeter area of the front panel to display the multimeter setting window. Click to select **A**.
- (2) Click **AC/DC** below to select AC and DC. When **ACI** is displayed at the multimeter display window, it indicates AC current is selected; when **DCI** is displayed, it indicates DC current is selected.
- (3) Connect the black test pen to the **COM** end of the front panel and the red test pen to the **20A** input end.
- (4) Turn off the power supply to the circuit under test. Discharge all high-voltage capacitors on the circuit under test.
- (5) Disconnect the circuit under test. Connect the black test pen to one end of

the disconnected circuit (its voltage is relative low) and the red test pen to the other end (its voltage is relative high). If it is connected reversely, the reading will be negative but it will not damage the multimeter.

- (6) Connect the power supply to the circuit and read the measured value.
- (7) Turn off the power supply to the circuit under test. Discharge all high-voltage capacitors. Remove the test pen and restore the circuit to its original state.

### Measure the Capacitance

- (1) Click the Multimeter display window or press **Setting** key at the multimeter area of the front panel to display the multimeter setting window. Click to select  $\text{HF}$  and enter the capacitance measurement.
- (2) Insert the capacitance meter attached with the instrument into the **COM** end and  $\text{V}\Omega\text{Hz}\text{F}$  input end of the front panel.
- (3) Insert the capacitor under test into the capacitance meter, and the capacitance reading of the capacitor under test will be displayed on the screen.

**Note:** When the capacitance to be measured is less than 5nF, the relative value measurement method can improve the accuracy of the measured value.

### Measure the Resistance

- (1) Click the Multimeter display window on the screen or press **Setting** key at the multimeter area of the front panel to display the multimeter setting window. Click to select  $\Omega/\text{kHz}/\text{Hz}$  and the measurement function is displayed as  $\Omega$  in the multimeter display window, then enter the resistance measurement mode.
- (2) Connect the black test pen to the **COM** end of the front panel and the red test pen to the  $\text{V}\Omega\text{Hz}\text{F}$  input end.
- (3) Connect the other end of the red test pen and the black test pen to the point to be tested respectively and read the displayed values.

## On-off Test

- (1) Click the Multimeter display window on the screen or press **Setting** key at the multimeter area of the front panel to display the multimeter setting window. Click to select  $\Omega/\blacktriangleleft/\blacktriangleright$  and click **Switch** below to switch the measurement function, until  $\blacktriangleleft$  is displayed at the multimeter display window, then enter the on-off test mode.
- (2) Connect the black test pen to the **COM** end of the front panel and the red test pen to the  $\blacktriangleleft$  input end.
- (3) Use the other end of the red test pen and the black test pen to measure the resistance of the circuit under test. If the resistance is less than 50  $\Omega$ , the buzzer will make a “beep” sound.

## Measure the Diode

- (1) Click the Multimeter display window on the screen or press **Setting** key at the multimeter area of the front panel to display the multimeter setting window. Click to select  $\Omega/\blacktriangleleft/\blacktriangleright$  and click **Switch** below to switch the measurement function, until  $\blacktriangleright$  is displayed at the multimeter display window, then enter the diode test mode.
- (2) Connect the black test pen to the **COM** end of the front panel and the red test pen to the  $\blacktriangleleft$  input end.
- (3) Connect the other end of the red test pen to the positive electrode of the diode and the other end of the black test pen to the negative electrode of the diode, and read the forward bias value of the diode under test.

## Multimeter Functions

### Reading Hold Mode

In the reading hold mode, the current reading keeps on the screen.

- (1) Click the Multimeter display window on the screen or press **Setting** key at the multimeter area of the front panel to display the multimeter setting

window. Click **Hold** key below and H is displayed at the multimeter display window, and the current reading keeps on the screen.

(2) Click **Hold** again to exit this mode.



## Conduct Relative Value Measurement

For relative measurement, the reading is the difference between the stored reference value and the input signal.

(1) Click the Multimeter display window on the screen or press **Setting** key at the multimeter area of the front panel to display the multimeter setting window. Click **Relative Value** key below and  $\Delta$  is displayed at the multimeter display window, then enter the relative value measurement mode; the measured value at this point is considered as a reference value and displayed below the current reading.

In this mode, Current Reading = Input Value – Reference Value.

(2) Click **Relative Value** again to exit this mode.

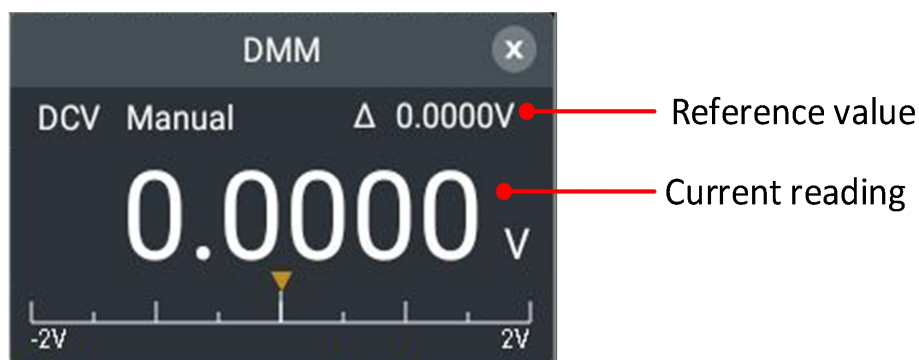

**Note:** This function is not available for measuring the resistance and diode and conducting on-off test.

## Select Auto/Manual Range

Auto range is preset. To select Auto/Manual range, perform the following steps:

- (1) Click the Multimeter display window on the screen or press **Setting** key at the multimeter area of the front panel to display the multimeter setting window. Click **Auto Range** key below to enter auto range mode and **Auto** is displayed at the multimeter display window.
- (2) Click **Manual Range** key to enter manual range mode and **Manual** is displayed at the Multimeter display window, continue to click **Manual Range** key to switch the range.

**Note:** Manual range mode is not available for capacitance measurement, 20A current measurement, on-off test and diode measurement.



# 9. Technical Specifications

Unless otherwise stated, all technical specifications apply to digital oscilloscope with the attenuation switch of the probe set to 10X.

- The instrument must be operated continuously for more than thirty minutes under the specified operating temperature.
- If the operating temperature range changes not less than 5°C, it is required to open the system function menu and execute “Self-calibration” program (See “How to conduct self-calibration” in Page 13).

All specifications are guaranteed except those marked with “Typical”.

## Oscilloscope

Performance Characteristics		Instruction			
<b>Bandwidth</b>		100 MHz			
<b>Vertical Resolution</b>		FDS1102	8 bits		
		FDS1102A	8 bits /12 bits /14 bits		
<b>Acquisition</b>	<b>Mode</b>	Normal, Peak detect, Averaging			
	<b>Real-time Acquisition Rate</b>	FDS1102	Dual CH	8 bits	500 MS/s
			Single CH		1 GS/s
		FDS1102A	Dual CH	8 bits mode	500 MS/s
				12 bits mode	250 MS/s
				14 bits mode	100 MS/s
			Single CH	8 bits mode	1 GS/s
	12 bits mode	500 MS/s			
	14 bits mode	100 MS/s			
	<b>Waveform Refresh Rate</b>		65,000 wfms/s		
<b>Channel</b>		2			
<b>Multi-level Gray Scale Display &amp; Color Temperature Display(Use gray scale to indicate frequency of occurrence,where frequently occurring waveform are bright.)</b>		Support			
<b>Horizontal Accuracy</b>		±20 ppm (typical value, ambient temperature: +25°C)			

<b>Input</b>	<b>Input Coupling</b>	DC, AC, grounding				
	<b>Input Impedance</b>	1 MΩ±2%, parallel with 15 pF±5 pF				
	<b>Probe attenuation coefficient</b>	10uX-50kX, step by 1 – 2 - 5, support custom				
	<b>Maximum Input Voltage</b>	1MΩ:≤300 Vrms				
	<b>Bandwidth limit</b>	20 MHz, full bandwidth				
	<b>Channel –channel isolation</b>	50 Hz: 100:1 10 MHz: 40:1				
	<b>Time delay between channel(typical)</b>	150ps				
<b>Horizon</b>	<b>Sampling rate range</b>	FDS1102	Dual CH	8 bits mode	0.05 S/s ~ 500 MS/s	
			Single CH		0.05 S/s ~ 1 GS/s	
		FDS1102A	Dual CH	8 bits mode	0.05 S/s ~ 500 MS/s	
				12 bits mode	0.05 S/s ~ 250 MS/s	
			Single CH	14 bits mode	0.05 S/s ~ 100 MS/s	
				8 bits mode	0.05 S/s ~ 1 GS/s	
	<b>Interpolation</b>	(Sinx)/x				
		<b>Maximum Storage Depth</b>	10M			
		<b>Scanning speed (S/div)</b>	2ns/div - 1000s/div, step by 1-2-5			
		<b>Relay time accuracy</b>	±20 ppm(typical, environment temperature is +25°C)			

9. Technical Specifications

	<b>Time interval(<math>\Delta T</math>) measurement accuracy(CD ~100MHz)</b>	Single: $\pm(1 \text{ interval time} + 1 \text{ ppm} \times \text{reading} + 0.6 \text{ ns})$ ; Average >16: $\pm(1 \text{ interval time} + 1 \text{ ppm} \times \text{reading} + 0.4 \text{ ns})$			
<b>Vertical</b>	<b>Vertical Sensitivity</b>	1 mV/div ~ 10 V/div			
	<b>Displacement</b>	$\pm 2V(1 \text{ mV/div} - 50 \text{ mV/div})$ ; $\pm 20 V(100 \text{ mV/div} - 1 V/div)$ ; $\pm 200 V(2 V/div - 10 V/div)$			
	<b>Analog bandwidth</b>	100 MHz			
	<b>Single bandwidth</b>	Full bandwidth			
	<b>Low Frequency(A C coupling , -3dB)</b>	$\geq 10 \text{ Hz(at BNC)}$			
	<b>Rising Time(at BNC, typical)</b>	$\leq 3.5 \text{ ns}$			
	<b>DC Gain Accuracy</b>	FDS1102	8 bits mode	1 mV	4%
				$\geq 2 \text{ mV}$	3%
		FDS1102A	8 bits mode	1 mV	4%
				$\geq 2 \text{ mV}$	3%
	12 bits mode	1 mV	3%		
	14 bits mode	$\geq 2 \text{ mV}$	2%		
<b>DC accuracy (average)</b>	Delta Volts between any two averages of $\geq 16$ waveforms acquired with the same scope setup and ambient conditions ( $\Delta V$ ): $\pm(3\% \text{ rdg} + 0.05 \text{ div})$				
	Waveform inverted ON/OFF				
<b>Trigger Type</b>	Edge trigger, video trigger, pulsewidth trigger, slope trigger, under-amplitude trigger, over-amplitude trigger, timeout trigger, Nth edge trigger, logic trigger, RS232/UART, I2C, SPI, CAN and LIN				
<b>Trigger Mode</b>	Auto, Normal, Single				
<b>Signal System and Line/Field Frequency (Video Trigger Mode)</b>	Support NTSC, PAL and SECAM broadcasting system of any field frequency or line frequency				

<b>Measurement</b>	<b>Cursor Measurement</b>	$\Delta V$ 、 $\Delta T$ 、 $\Delta T \& \Delta V$ between cursors、 auto cursor、 support XY/FFT/ZOOM window、 based on screen percentage
	<b>Auto Measurement</b>	Period, Frequency, +Pulse Width, -Pulse Width, Rise Time, Fall Time, Screen Duty, +Duty Cycle, -Duty Cycle, Mean, PK-PK, RMS, OverShoot, Max, Min, Vtop, Cycle RMS, Vbase, Vamp, PreShoot, +PulseCount, -PulseCount, RiseEdgeCnt, FallEdgeCnt, Area, Cycle Area, Delay A->B $\Phi$ 、 Delay A->B $\Psi$ 、 Phase、 FRR、 FRF、 FFR、 FFF、 LRR、 LRF、 LFR、 LFF
	<b>Mathematical operation</b>	+、-、*、/、Intg、Diff、Sqrt、Function operation(Lg/Ln/Exp/Abs/Sine/Cosine/Tan)、User Defined Function、digital filter(low pass, high pass, band pass, band reject)FFT、 FFTrms

## Trigger

Performance Characteristics		Instruction
<b>Trigger level range</b>	Internal	$\pm 5$ div from the screen center
	EXT	$\pm 2V$
	EXT/5	$\pm 10V$
<b>Trigger level Accuracy (typical)the source is adapted to rising and falling time <math>\geq 20ns</math></b>	Internal	$\pm 0.3$ div
	EXT	$\pm (10 \text{ mV} + 6\% \text{ Set value})$
	EXT/5	$\pm (50 \text{ mV} + 6\% \text{ Set value})$
<b>Trigger displacement</b>	According to Record length and time base	
<b>Trigger Holdoff range</b>	100 ns – 10 s	
<b>50% level setting (typical)</b>	Input signal frequency $\geq 50$ Hz	
<b>Edge Trigger</b>	slope	Rising, Falling
<b>Video Trigger</b>	Modulation	Support standard NTSC, PAL and SECAM broadcast systems
	Line number range	1-525 (NTSC) and 1-625 (PAL/SECAM)
<b>Pulse Trigger</b>	Trigger	Positive pulse: >, <, =

9. Technical Specifications

	condition	Negative pulse: >, <, =
	Pulse Width range	30 ns to 10 s
<b>Slope Trigger</b>	Trigger condition	Positive pulse: >, <, = Negative pulse: >, <, =
	Time setting	30 ns to 10 s
<b>Runt Trigger</b>	Polarity	Positive, Negative
	Pulse Width Condition	>, =, <
	Pulse Width Range	30 ns to 10 s
<b>Windows Trigger</b>	Polarity	Positive, Negative
	Trigger Position	Enter, Exit, Time
	Windows Time	30 ns to 10 s
<b>Timeout Trigger</b>	Edge Type	Rising, Falling
	Idle Time	30 ns to 10 s
<b>The Nth Edge Trigger</b>	Edge Type	Rising, Falling
	Idle Time	30 ns to 10 s
	Edge Number	1 to 128
<b>Logic trigger</b>	Logic Mode	AND, OR, XNOR, XOR
	Input Mode	H, L, X, Rising, Falling
	Output Mode	Goes True, Goes False, Is True >, Is True <, Is True =
<b>RS232/UART Trigger</b>	Polarity	Normal, Inverted
	Trigger Condition	Start, Error, Check Error, Data
	Baud Rate	Common, Custom
	Data Bits	5 bit, 6 bit, 7 bit, 8 bit
<b>I2C Trigger</b>	Trigger Condition	Start, Restart, Stop, ACK Lost, Address, Data, Addr/Data
	Address Bits	7 bit, 8 bit, 10 bit
	Address Range	0 to 127, 0 to 255, 0 to 1023
	Byte Length	1 to 5
<b>SPI Trigger</b>	Trigger Condition	Timeout
	Timeout Value	30 ns to 10 s
	Data Bits	4 bit to 32 bit
	Edge	Rising, Falling

<b>CAN Trigger</b>	Signal Type	CAN_H, CAN_L, TX, RX
	Trigger Condition	Start of Frame, Type of Frame, Identifier, Data, ID & Data, End of Frame, Missing Ack, Bit Stuffing Error
	Baud Rate	Common, Custom
	Sample Point	5% to 95%
	Frame Type	Data, Remote, Error, Overload
<b>LIN Trigger</b>	Condition	Interval, ID, ID/Data, Data Error
	Baud Rate	Common, Custom

## Waveform Generator

Bandwidth	50 MHz
Sample Rate	300M Sa/s
Vertical Resolution	14 bits
Channel	2
<b>Waveforms</b>	
Standard waveforms	Sine wave, square wave, ramp wave, pulse wave, noise
Arbitrary waveforms	exponential rise, exponential decline, Sin(x)/x, step wave, noise etc 28 build-in waveforms
<b>Frequency Feature</b>	
Sine wave	1 $\mu$ Hz to 50 MHz
Square wave	1 $\mu$ Hz to 25 MHz
Ramp wave	1 $\mu$ Hz to 1 MHz
Pulse wave	1 $\mu$ Hz to 10 MHz
Noise wave(-3 dB)	20 MHz(Gaussian white noise)
Arbitrary wave(except DC)	1 $\mu$ Hz to 10 MHz
Frequency resolution	1 $\mu$ Hz or 7 significant figures
Frequency stability	$\pm$ 30 ppm at 0 to 40°C
Frequency aging rate	$\pm$ 30 ppm per year
<b>Amplitude characteristic</b>	
Output	High Z 2mVpp to 10Vpp

9. Technical Specifications

amplitude	50Ω	1mVpp to 5Vpp
Amplitude accuracy		±(1% of setting + 1 mVpp)(typical 1kHz sine,0V offset)
Amplitude resolution		1mVpp or 4 digits
DC offset range (AC+DC)	High Z	±5 Vpk - Amplitude Vpp/2
	50Ω	±2.5 Vpk - Amplitude Vpp/2
	Note:	When offset >2.5Vpp, amplitude ≥10mV(High Z) When offset >1.25Vpp, amplitude ≥5mV(50Ω)
DC offset accuracy		±(1 % of  setting + 1 mV + amplitude Vpp * 0.5%)
Offset resolution		1mVpp
Output Impedance		50Ω(typical)
<b>Waveforms characteristic</b>		
<b>Sine</b>		
Bandwidth flatness(1Vpp , relative 1kHz,50Ω)		≤10MHz:±0.3dB ≤50MHz:±0.5dB
Harmonic distortion		Typical value(0dBm) DC to 1MHz:<-65dBc 1MHz to 50MHz:<-60dBc
Total harmonic distortion		<0.2%, 10Hz to 20kHz, 1Vpp
Non-harmonic distortion		Typical value(0dBm) ≤10MHz:<70dBc; >10MHz:<70dBc+6c/sound interval
Phase noise		Typical value(0dBm, 10kHz offset) 10MHz:≤-110dBc/Hz
<b>Square</b>		
Rising falling time		<20ns
Jitter		200ps +30ppm
Overshoot		<5%
<b>Zigzag</b>		
Linearity		<the 1% of maximum output(typical value 1 kHz , 1 Vpp , symmetry50%)

## 9. Technical Specifications

Symmetry	0% to 100%
<b>Pulse</b>	
Period	100ns to 1Ms
Pulsewidth	≥40ns
Overshoot	<5%
Jitter	200ps +30ppm
<b>Noise</b>	
Type	Gaussian white noise
Bandwidth (-3dB)	20 MHz
<b>Arbitrary</b>	
Bandwidth	10MHz
Waveforms length	2 to 8192 points
Sample rate	300M Sa/s
Amplitude accuracy	14bits
<b>Modulation characteristic</b>	
Modulate type	AM, FM, PM, FSK
<b>AM</b>	
Carrier	Sine、Square、Zigzag、Arb(Except DC)
Internal modulation waveform	Sine、Square、Zigzag、Noise
Internal amplitude modulation frequency	2 mHz to 20 kHz
Depth	0% to 100%
<b>FM</b>	
Carrier	Sine、Square、Zigzag、Arb(Except DC)
Internal modulation waveform	Sine、Square、Zigzag、Noise
Internal modulation frequency	2 mHz to 20 kHz
Frequency offset	2 mHz to Carrier frequent
<b>PM</b>	
Carrier	Sine、Square、Zigzag、Arb(Except DC)
Internal	Sine、Square、Zigzag、Noise



modulation waveform	
Internal phase modulation frequency	2 mHz to 20 kHz
Phase deviation range	0° to 180°
<b>FSK</b>	
Carrier	Sine、Square、Zigzag、Arb(Except DC)
FSK rate	2 mHz to 100kHz
FSK hopfreq	1 μHz to Maximum frequency of corresponding carrier
<b>Sweep</b>	
Carrier	Sine、Square、Zigzag、Arb(Except DC)
Min/Max start frequent	1μHz(minimum)/Maximum frequency of corresponding carrier
Max/Min stop frequent	1μHz(minimum)/Maximum frequency of corresponding carrier
Type	Line、Log
Sweep time	1 ms to 500 s ± 0.1%
Trigger source	Internal、Manual
<b>Pulse string</b>	
Waveforms	Sine、Square、Zigzag、Pulse and Arb(Except DC)
Carrier frequency	1 μHz to Maximum frequency of corresponding carrier /2
Trigger source	Manual、Internal
N-cycle trigger cycle	1 us to 500s
N periodicity	1 to 400000 (Max =Burst Period / Period)/infinite
<b>Voltage range and sensitivity(No modulation source)</b>	
Input resistance	1M Ω

## Power Supply

<b>Rated output</b>	
Voltage	0.1~15V
Current	0.1~3A
Power	15W
<b>Load Regulation</b>	
Voltage	≤0.1%+3mV
Current	≤0.1%+3mA

<b>Power Regulation</b>	
Voltage	$\leq 0.1\% + 3\text{mV}$
Current	$\leq 0.1\% + 3\text{mA}$
<b>Noise &amp; Ripple(20Hz-20MHz)</b>	
Voltage(Vp-p)	$\leq 10\text{mVp-p}$
Voltage(rms)	$\leq 2\text{mVrms}$
Current(rms)	$\leq 5\text{mA rms}$
<b>Settings Resolution</b>	
Voltage	10mV
Current	10mA
<b>Read Back Resolution</b>	
Voltage	10mV
Current	1mA
<b>Settings Accuracy(25°C±5°C)</b>	
Voltage	$\leq 0.8\% + 10\text{mV}$
Current	$\leq 1\% + 8\text{mA}$
<b>Read Back Accuracy(25°C ± 5°C)</b>	
Voltage	$\leq 0.3\% + 10\text{mV}$
Current	$\leq 0.3\% + 8\text{mA}$
<b>Response time</b>	
Transient recovery time(50% ~ 100% rated load)	$\leq 1\text{ms}$
<b>Protect function</b>	
OVP	0~16V
OCP	0~3.1A

## Multimeter

Function		Measurement Range	Resolution	Function
<b>DC Voltage (V)</b>	mV	20.000 mV/200.00 mV	0.001mV	$\pm(0.5\% + 10\text{dig})$
	V	2.0000V/20.000V/200.00V	0.1mV	$\pm(0.3\% + 5\text{dig})$
		1000.0V	0.1V	$\pm(0.5\% + 5\text{dig})$
<b>AC Voltage (V)</b>	mV	20.000 mV/200.00 mV	0.001mV	$\pm(0.8\% + 10\text{dig})$
	V	2.0000V/20.000V/200.00V	0.1mV	$\pm(0.8\% + 10\text{dig})$
		750.0V	0.1V	$\pm(1\% + 10\text{dig})$
<b>DC</b>	$\mu\text{A}$	200.00 $\mu\text{A}$ /2000.0 $\mu\text{A}$	0.01 $\mu\text{A}$	$\pm(0.5\% + 10\text{dig})$

<b>Current (A)</b>	mA	20.000mA/200.00mA	0.001mA	±(0.5%+10dig)
	A	20.000A [1]	0.001A	±(2%+10dig)
<b>AC Current (A)</b>	μA	200.00μA/2000.0μA	0.01μA	±(0.8%+10dig)
	mA	20.000mA/200.00mA	0.001mA	±(0.8%+10dig)
	A	20.000A [1]	0.001A	±(2.5%+10dig)
<b>Resistance (Ω)</b>		200.00Ω/2.0000kΩ/20.000kΩ/20.00kΩ/2.0000MΩ/20.000MΩ	0.01Ω	±(0.8%+10dig)
		100.00MΩ	0.01 MΩ	±(5%+10dig)
<b>Capacitance (F)</b>		2.0000nF/20.000nF/200.00nF/2.0000μF/20.000μF	0.1pF	±(4%+10dig)
		200.00μF/2.0000mF/20.000mF [2]	0.01μF	±(4%+10dig)
<b>Duty Cycle (%)</b> <sup>[3]</sup>		0.1% - 99.9% (Typical: V <sub>rms</sub> =1 V, f=1 kHz)	0.1%	±(1.2%+3dig)
		0.1% - 99.9%(≥1 kHz)		±(2.5%+3dig)

[1] When measuring current, for 10 A to 15 A, the measuring duration should not be over 2 minutes within 10 minutes, and in this 10 minutes, no other current should flow through except within the measuring duration; for 15 A to 20 A, the measuring duration should not be over 10 seconds within 15 minutes, and in this 15 minutes, no other current should flow through except within the measuring duration.

[2] When measuring big capacitance, the measuring duration should be over 30 seconds.

[3] When measuring duty cycle, the typical waveform is Square.

**Note:**

- **Standard conditions: The environment temperature is 18°C to 28°C, the relative humidity is less than 80%.**
- **When measuring AC voltage/current or capacitance, accuracy guarantee range is 5% to 100% of the range.**
- **When measuring resistance and capacitance, the influence of the resistance reactance of the pen itself on the measured value should be considered.**

Characteristics	Instruction
Display	19999
Frequency Response (Hz)	(40 - 1000) Hz
Sample rate for digital data	3 times/second
Auto ranging	√
True Virtual Value	√
Diodes Test	√

<b>On-off Buzzer</b>	√
<b>Data Hold</b>	√
<b>Relative Measurement</b>	√
<b>Input Protection</b>	√
<b>Input Impedance</b>	≥10 MΩ

## General Technical Specifications

### Display:

Characteristics	Instruction
Display Type	10.4 inch Colored LCD (Liquid Crystal Display)
Display Resolution	1024 (Horizontal) ×768 (Vertical) Pixels
Display Colors	65536 colors, TFT

### Output of the Probe Compensator:

Characteristics	Instruction
<b>Output voltage(typical)</b>	About 5 V, with the Peak-to-Peak voltage ≥1
<b>Frequent(typical)</b>	Square wave of 1 KHz

### Others:

Characteristics	Instruction
<b>Communication Interface</b>	HDMI; USB dev*1, USB Host *4; Trig Out(P/F); LAN interface; earphone jack
<b>Power Supply</b>	100V – 240 VACRMS, 50/60 Hz, CAT II
<b>Power Consumption</b>	PWR empty load <30W
	PWR full load <90W
<b>Fuse</b>	2 A, T class, 250 V
<b>Touch Screen</b>	Multi-touch capacitive touch screen

### Environment:

Characteristics	Instruction
<b>Temperature</b>	Working temperature:0℃~40℃ Storage temperature:-20℃~+60℃
<b>relative humanity</b>	≤90%

## 9. Technical Specifications

---

<b>Height</b>	Operating: 3,000 m Non-operating: 15,000 m
<b>Cooling Method</b>	Fan cooling

### **Mechanical Specifications:**

<b>Characteristics</b>	<b>Instruction</b>
<b>Dimension</b>	421 mm × 221 mm × 115 mm (L*H*W)
<b>Weight</b>	Approx. 4.25 kg (without accessories)

### **Interval Period of Adjustment:**

One year is recommended for the calibration interval period.

# 10.Appendix

## Appendix A: Enclosure

(The accessories subject to final delivery.)

### Standard Accessories:



Power Cord



Quick Guide



USB Cable



Probe



Probe Adjust



Multimeter Lead



BNC to alligator  
clip Q9 cable



banana plug to  
alligator clip cable

## Appendix B: General Care and Cleaning

### General Care

Do not store or leave the instrument where the liquid crystal display will be exposed to direct sunlight for long periods of time.

**Caution:** To avoid any damage to the instrument or probe, do not exposed it to any sprays, liquids, or solvents.

### Cleaning

Inspect the instrument and probes as often as operating conditions require. To clean the instrument exterior, perform the following steps:

1. Wipe the dust from the instrument and probe surface with a soft cloth. Do not make any scuffing on the transparent LCD protection screen when clean the LCD screen.
2. Disconnect power before cleaning your Oscilloscope. Clean the instrument with a wet soft cloth not dripping water. It is recommended to scrub with soft detergent or fresh water. To avoid damage to the instrument or probe, do not use any corrosive chemical cleaning agent.



**Warning:** Before power on again for operation, it is required to confirm that the instrument has already been dried completely, avoiding any electrical short circuit or bodily injury resulting from the moisture.

---